

# SEQUENTIAL MULTICATEGORIES

CLAUDIO PISANI

## ABSTRACT.

We study the monoidal closed category of symmetric multicategories, especially in relation with its cartesian structure and with sequential multicategories (whose arrows are sequences of concurrent arrows in a given category). Then we consider cartesian multicategories in a similar perspective and develop some peculiar items such as algebraic products. Several classical facts arise as a consequence of this analysis when some of the multicategories involved are representable.

## 1. Introduction

The overall aim of the present work is to show how symmetric and cartesian multicategories offer a natural framework encompassing several aspects of the theory of symmetric monoidal and finite product categories.

It is well known for instance that “preadditive” categories, whose hom-sets are commutative monoids and composition is distributive, occupy a special place among enriched categories. Here they are characterized as the categories of commutative monoids in a cartesian multicategory (Corollary 4.19, p. 537); consequently, the (semi)additive categories are characterized as the categories of commutative monoids in a finite product category (Corollary 4.20, p. 538).

A crucial role is played by the “Boardman-Vogt” monoidal closed structure on the category  $\mathbf{sMlt}$  of symmetric multicategories (see [Weiss, 2011] and [Trova, 2010]). The internal hom  $[\mathcal{M}, \mathcal{N}]$  has as objects the functors  $F : \mathcal{M} \rightarrow \mathcal{N}$  in  $\mathbf{sMlt}$  and as arrows  $\alpha : F_1, \dots, F_n \rightarrow F$  the families of arrows  $\alpha_A : F_1 A, \dots, F_n A \rightarrow F A$  in  $\mathcal{N}$  ( $A \in \mathcal{M}$ ), such that the following “naturality” condition holds for any arrow  $f : A_1, \dots, A_m \rightarrow A$  in  $\mathcal{M}$ :

$$Ff(\alpha_{A_1}, \dots, \alpha_{A_m}) = \sigma \alpha_A(F_1 f, \dots, F_n f)$$

where  $\sigma$  is the obvious permutation. The composition and the symmetric structure are inherited pointwise from  $\mathcal{N}$  (see also [Tronin, 2011]). If  $\mathcal{N}$  is associated to a symmetric monoidal structure (that is, if it is representable) or has a cartesian structure, these are also inherited pointwise by  $[\mathcal{M}, \mathcal{N}]$  (Proposition 3.17, p. 515, and Proposition 4.18, p. 535).

---

Received by the editors 2014-04-21 and, in revised form, 2014-09-12.

Transmitted by F. W. Lawvere. Published on 2014-09-15.

2010 Mathematics Subject Classification: 18C10, 18D10, 18D50, 18D99, 18E05.

Key words and phrases: Sequential, representable, exponentiable and cartesian multicategories; preadditive, additive and finite product categories; Boardman-Vogt tensor product.

© Claudio Pisani, 2014. Permission to copy for private use granted.

In particular, if  $1_{\blacktriangleright} \in \mathbf{sMlt}$  is the terminal multicategory, then  $[1_{\blacktriangleright}, \mathcal{M}] \in \mathbf{sMlt}$  is the multicategory of commutative monoids in  $\mathcal{M}$ . We call “sequential” these multicategories  $[1_{\blacktriangleright}, \mathcal{M}]$  of commutative monoids, since they can be also characterized as those of the form  $\mathcal{C}_{\blacktriangleright}$ , where  $(-)_{\blacktriangleright} : \mathbf{Cat} \rightarrow \mathbf{sMlt}$  is the fully faithful “discrete cocones” functor:

$$\mathcal{C}_{\blacktriangleright}(X_1, \dots, X_n; X) \cong \mathcal{C}(X_1, X) \times \dots \times \mathcal{C}(X_n, X) .$$

So  $n$ -ary arrows in  $\mathcal{C}_{\blacktriangleright}$  are sequences  $\langle f_1, \dots, f_n \rangle$  of concurrent arrows in  $\mathcal{C}$  with the obvious composition, for instance

$$\langle f, g, h \rangle(\langle l, t \rangle, \langle \rangle, \langle q \rangle) = \langle fl, ft, hq \rangle$$

and for any functor  $F : \mathcal{C} \rightarrow \mathcal{D}$

$$F_{\blacktriangleright} \langle f_1, \dots, f_n \rangle = \langle Ff_1, \dots, Ff_n \rangle .$$

We denote by  $\mathbf{Seq} \subset \mathbf{sMlt}$  the full subcategory of sequential multicategories, so that there is an equivalence  $\mathbf{Seq} \simeq \mathbf{Cat}$ . In fact,  $[1_{\blacktriangleright}, \mathcal{M}]$  is the coreflection of  $\mathcal{M}$  in  $\mathbf{Seq}$ , while  $1_{\blacktriangleright} \otimes \mathcal{M}$  is its reflection (Corollary 3.9, p. 514).

The relation between (symmetric) monoidal categories and (symmetric) multicategories is well known (see for instance [Lambek, 1989], [Hermida, 2000] and [Leinster, 2003]); if  $(\mathcal{C}, I, \otimes)$  is a monoidal category, one gets a multicategory  $\mathcal{C}_{\otimes}$  by

$$\mathcal{C}_{\otimes}(X_1, \dots, X_n; X) = \mathcal{C}(X_1 \otimes \dots \otimes X_n, X)$$

(where the particular choice of bracketing is omitted). In fact, there is an equivalence between the category of (symmetric) monoidal categories and lax monoidal functors and the category  $\mathbf{Rep} \subset \mathbf{Mlt}$  ( $\mathbf{sRep} \subset \mathbf{sMlt}$ ) of representable (symmetric) multicategories. Working directly in  $\mathbf{Rep}$  has the advantage that coherence issues are replaced by the more natural universal issues.

Since  $\mathcal{C}_{\blacktriangleright}$  is representable if, and only if,  $\mathcal{C}$  has finite coproducts, the full subcategory  $\mathbf{Sum} := \mathbf{Seq} \cap \mathbf{sRep} \subset \mathbf{sMlt}$  is equivalent to the category of categories with finite coproducts and all functors (Proposition 3.16, p. 515). Thus  $[1_{\blacktriangleright}, -]$  gives also the coreflection of  $\mathbf{sRep}$  in  $\mathbf{Sum}$  (Corollary 3.19, p. 520), and finite sum categories can be characterized as the categories of commutative monoids in a symmetric monoidal category.

Let us consider now the category  $\mathbf{fpMlt}$  of cartesian multicategories (see for instance [Gould, 2008] and the references therein; see also Section 4.1, p. 521). If  $\mathcal{M} \in \mathbf{fpMlt}$  there are in particular “contraction” mappings

$$\gamma_n : \mathcal{M}(A, \dots, A; B) \rightarrow \mathcal{M}(A; B) .$$

We will see that giving a cartesian structure on a sequential multicategory  $\mathcal{C}_{\blacktriangleright}$  is equivalent to giving a preadditive structure on  $\mathcal{C}$ , where contractions correspond to sums of maps. Thus the full subcategory  $\mathbf{fpSeq} \subset \mathbf{fpMlt}$  of sequential cartesian multicategories is equivalent to the category of preadditive categories and additive functors (Proposition 4.12,

p. 533), and  $[1_{\bullet}, -]$  gives also the coreflection of  $\mathbf{fpMlt}$  in  $\mathbf{fpSeq}$  (Corollary 4.19, p. 537). In particular, we get the characterization of preadditive categories mentioned at the beginning of this introduction; indeed, the preadditive category corresponding to  $[1_{\bullet}, \mathcal{M}]$  is the category  $\mathbf{cMon}(\mathcal{M})$  of commutative monoids in  $\mathcal{M}$ , with the sum of the monoid morphisms  $f_1, \dots, f_n : M \rightarrow N$  given by the contraction

$$\gamma_n m^n(f_1, \dots, f_n)$$

(the arrows  $m^n : N, \dots, N \rightarrow N$  being the monoid structure).

A useful perspective is to consider symmetric and cartesian multicategories as two doctrines (in the sense of Lawvere’s categorical logic): that of “linear” theories and that of algebraic theories, respectively. In fact finite product categories, which are the usual many-sorted version of Lawvere theories (see for instance [Adamek et al., 2011]), are included in  $\mathbf{fpMlt}$  as the representable cartesian multicategories.

In this perspective, the category of models of  $\mathcal{M}$  in  $\mathcal{N}$ ,  $\mathbf{sMlt}(\mathcal{M}, \mathcal{N})$  or  $\mathbf{fpMlt}(\mathcal{M}, \mathcal{N})$ , has itself the structure of a symmetric or cartesian multicategory:

$$[\mathcal{M}, \mathcal{N}] \quad ; \quad [\mathcal{M}, \mathcal{N}]_{fp}$$

(where  $[\mathcal{M}, \mathcal{N}]_{fp}$  is the internal hom for a monoidal closed structure on  $\mathbf{fpMlt}$ ; see Section 4.24, p. 539). Therefore it makes sense to consider models valued in  $[\mathcal{M}, \mathcal{N}]$  or  $[\mathcal{M}, \mathcal{N}]_{fp}$  and the Boardman-Vogt tensor product (on  $\mathbf{sMlt}$  or  $\mathbf{fpMlt}$ ) and sequential multicategories play the same role that the Kronecker product and annular theories play in Lawvere theories (see [Freyd, 1966], [Lawvere, 2004] and [Wraith, 1970]).

On the symmetric level, categories  $\mathcal{C} \in \mathbf{Cat}$  parameterize two important sorts of linear theories: the unary ones  $\mathcal{C}^-$  (which have only unary arrows) and the sequential ones  $\mathcal{C}_{\bullet}$ :

$$(-)^- : \mathbf{Cat} \rightarrow \mathbf{sMlt} \quad ; \quad (-)_{\bullet} : \mathbf{Cat} \rightarrow \mathbf{sMlt} .$$

For instance (considering the basic background  $\mathbf{Set}$ ), the models for  $1_{\bullet}$  are commutative monoids, the models for  $\mathcal{C}^-$  are presheaves on  $\mathcal{C}$ , and the isomorphism  $\mathcal{C}_{\bullet} \cong \mathcal{C}^- \otimes 1_{\bullet}$  (Proposition 3.3, p. 510) says that the models for  $\mathcal{C}_{\bullet}$  are monoids in  $\mathcal{C}$ -presheaves (or  $\mathcal{C}$ -presheaves of monoids).

On the cartesian level, preadditive categories parameterize “annular” theories

$$(-)_{\bullet} : \mathbf{cMon-Cat} \rightarrow \mathbf{fpMlt}$$

and a consequence of the coreflection  $[1_{\bullet}, -] : \mathbf{fpMlt} \rightarrow \mathbf{fpSeq}$  is that the models in any cartesian multicategory  $\mathcal{M}$  for an annular theory, namely the functors  $\mathcal{C}_{\bullet} \rightarrow \mathcal{M}$  in  $\mathbf{fpMlt}$ , are indeed (generalized) modules  $\mathcal{C}_{\bullet} \rightarrow [1_{\bullet}, \mathcal{M}]$ , that is they are additive functors  $\mathcal{C} \rightarrow \mathbf{cMon}(\mathcal{M})$ .

Summarizing, the category  $\mathbf{sMlt}$  of symmetric multicategories includes the category  $\mathbf{Cat}$  of categories in two ways (as sequential multicategories and as unary multicategories) as well as the category of symmetric monoidal categories (as representable multicategories). Similarly, the category  $\mathbf{fpMlt}$  of cartesian multicategories includes preadditive

categories (as sequential multicategories) and finite product categories (as representable multicategories). The two levels are themselves related by an adjunction and in both cases the closed structure (in particular the monoid construction) plays a prominent role; it restricts, on sequential multicategories, to the cartesian closed structure of **Cat** and to the monoidal closed structure of **cMon-Cat** respectively. This unifying role of multicategories, along with the perspective of categorical logic and a feasible diagrammatic calculus, provides an effective point of view on some aspects of category theory.

Some of the items studied here have been considered also in [Pisani, 2013].

1.1. **SUMMARY.** In Section 2 we shortly review some basic aspects of multicategories and investigate the cartesian structure of **MIt**. In particular, we observe that the exponentiable multicategories coincide with the promonoidal ones (Proposition 2.8, p. 503). In this perspective, Day convolution appears as the monoidal structure on the exponential  $\mathcal{N}^{\mathcal{M}}$  in **MIt** when  $\mathcal{M}$  is promonoidal and  $\mathcal{N}$  is monoidal (i.e., is representable) and cocomplete (Proposition 2.12, p. 505).

If  $\mathcal{M}$  is sequential, we have a particularly simple formula for the exponential  $\mathcal{N}^{\mathcal{M}}$  (Section 2.13, p. 505):

$$\mathcal{N}^{\mathcal{M}}(F_1, \dots, F_n; F) = \int_A \mathcal{N}(F_1 A, \dots, F_n A; F A) ,$$

that is an arrow  $\alpha : F_1, \dots, F_n \rightarrow F$  in  $\mathcal{N}^{\mathcal{M}}$  consists of arrows  $\alpha_A : F_1 A, \dots, F_n A \rightarrow F A$  ( $A \in \mathcal{M}$ ) such that for any unary arrow  $f : A \rightarrow B$  in  $\mathcal{M}$

$$\alpha_B(F_1 f, \dots, F_n f) = (F f) \alpha_A .$$

In Section 3 we study the monoidal closed structure of **sMIt** and compare it with the cartesian one. The main points are:

- $[\mathcal{C}^-, \mathcal{N}] \cong \mathcal{N}^{\mathcal{C}^-}$  and  $\mathcal{C}^- \otimes \mathcal{N} \cong \mathcal{C}^- \times \mathcal{N}$  (Proposition 3.3, p. 510), so that the cartesian and the monoidal structures in fact coincide on **Seq**  $\subset$  **sMIt**.
- Sequential multicategories are characterized as those with a “central monoid” (Proposition 3.6, p. 511).
- Sequential multicategories form an ideal with respect to  $\otimes$  and  $[-, -]$  on both sides (Corollary 3.7, p. 513).
- The functors  $1_{\blacktriangleright} \otimes -$  and  $[1_{\blacktriangleright}, -]$  give respectively a reflection and a coreflection of **sMIt** in **Seq** (Corollary 3.9, p. 514).
- If  $\mathcal{N}$  is representable, then so is  $[\mathcal{M}, \mathcal{N}]$ , for any  $\mathcal{M} \in$  **sMIt** (Proposition 3.17, p. 515).

As a consequence, we derive under a unified perspective the following facts (which seem to be well known at least as folklore):

- If  $\mathcal{M}$  is symmetric monoidal, the category  $\mathbf{cMon}(\mathcal{M})$  of commutative monoids in  $\mathcal{M}$  is cocartesian with the tensor product inherited by  $\mathcal{M}$ , and the functor  $\mathbf{cMon}(-)$  gives a right adjoint to the inclusion of cocartesian categories in the monoidal ones (corollaries 3.19 and 3.20, p. 520).
- A symmetric monoidal category is cocartesian if, and only if, it has a “central monoid” (Proposition 3.21, p. 520).

In Section 4 we move to the level of cartesian multicategories.

If  $\mathcal{C}$  is a finite product category, then  $\mathcal{C}_\times$  (i.e.,  $\mathcal{C}_\otimes$  with  $\otimes = \times$ ) has a cartesian structure. In fact, the full subcategory  $\mathbf{fpRep} \subset \mathbf{fpMlt}$  of representable cartesian multicategories is equivalent to the category of finite product categories and finite product preserving functors (Proposition 4.9, p. 532).

If  $\mathcal{C}$  is preadditive, i.e., it is enriched in commutative monoids, then  $\mathcal{C}_\bullet$  has a cartesian structure. In fact, the full subcategory  $\mathbf{fpSeq} \subset \mathbf{fpMlt}$  of sequential cartesian multicategories is equivalent to the category of preadditive categories and additive functors (Proposition 4.12, p. 533).

The view of cartesian multicategories as a common generalization of finite product categories and of preadditive categories is not devoid of consequences:

- $\mathbf{fpRep} \cap \mathbf{fpSeq} \subset \mathbf{fpMlt}$  is equivalent to the category of additive categories (that is preadditive categories with (bi)products) and additive functors.
- If  $\mathcal{M} \in \mathbf{fpSeq}$  and  $\mathcal{N} \in \mathbf{fpRep}$ , the morphisms  $\mathcal{M} \rightarrow \mathcal{N}$  in  $\mathbf{fpMlt}$  can be seen as generalized modules. In particular, if  $\mathcal{M}$  is an operad (that is, has just one object) the morphisms  $\mathcal{M} \rightarrow \mathbf{Set}_\times$  coincide with the (semi)modules over the rig  $\mathcal{M}$ .
- A cartesian multicategory is representable if, and only if, it has “algebraic products” (Corollary 4.10, p. 533), which in the sequential case reduce to ordinary algebraic biproducts. In fact, the well-known interplay between  $\mathbf{cMon}$ -enrichments, products, coproducts and biproducts arises as a particular case of more general properties of cartesian multicategories (Corollary 4.16, p. 534).

## 2. The cartesian structure of the category of multicategories

For an introduction to plain and symmetric multicategories (also known as coloured operads) the reader may consult for instance [Leinster, 2003] and [Trova, 2010]. Note that a symmetric structure on a multicategory can be defined in the same way as a cartesian structure, except that only maps with a bijective shape are supposed to act on the hom-sets (see Section 4). We do not consider here generalized or enriched multicategories.

We denote by  $\mathbf{Mlt}$  the category of multicategories and functors, and by  $\mathbf{sMlt}$  the category of symmetric multicategories and (symmetric) functors. Recall that given  $F, G :$

$\mathcal{M} \rightarrow \mathcal{N}$ , a natural transformation  $\alpha : F \rightarrow G$  consists of a family of unary arrows  $\alpha_A : FA \rightarrow GA$  ( $A \in \mathcal{M}$ ) such that for any arrow  $f : A_1, \dots, A_n \rightarrow A$  in  $\mathcal{M}$

$$Gf(\alpha_{A_1}, \dots, \alpha_{A_n}) = \alpha_A Ff .$$

Thus **Mlt** and **sMlt** are in fact 2-categories, with natural transformations as 2-cells.

2.1. THE UNARY EMBEDDING AND THE UNDERLYING FUNCTOR. A category  $\mathcal{C}$  gives rise to a (symmetric) “unary” multicategory  $\mathcal{C}^-$  consisting only of unary arrows:

$$\mathcal{C}^-(X; Y) = \mathcal{C}(X, Y) \quad ; \quad \mathcal{C}^-(X_1, \dots, X_n; Y) = \emptyset \quad (n \neq 1)$$

and the construction clearly extends to full and faithful 2-functors:

$$(-)^- : \mathbf{Cat} \rightarrow \mathbf{Mlt} \quad ; \quad (-)^- : \mathbf{Cat} \rightarrow \mathbf{sMlt} .$$

In the other direction, there are underlying 2-functors which take any multicategory  $\mathcal{M}$  to the category  $\mathcal{M}_-$  with  $\mathcal{M}_-(X, Y) = \mathcal{M}(X; Y)$ . It is immediate to verify that there are adjunctions

$$(-)^- \dashv (-)_- : \mathbf{Mlt} \rightarrow \mathbf{Cat} \quad ; \quad (-)^- \dashv (-)_- : \mathbf{sMlt} \rightarrow \mathbf{Cat} .$$

2.2. REMARK. The adjunction  $(-)^- \dashv (-)_-$  satisfies the Frobenius law:

$$\mathcal{M} \times \mathcal{C}^- \cong (\mathcal{M}_- \times \mathcal{C})^-$$

In particular,  $\mathcal{M} \times 1^- \cong (\mathcal{M}_-)^-$ .

2.3. THE SEQUENTIAL EMBEDDING. The discrete cocones functor  $(-)_\blacktriangleright : \mathbf{Cat} \rightarrow \mathbf{Mlt}$  mentioned in the introduction (see also [Hermida, 2000]) is in fact a full and faithful 2-functor. For fullness, let  $F : \mathcal{C}_\blacktriangleright \rightarrow \mathcal{D}_\blacktriangleright$  be a functor in **Mlt**,  $\langle f, g \rangle \in \mathcal{C}_\blacktriangleright(X, Y; Z)$ , and  $F\langle f, g \rangle = \langle f', g' \rangle \in \mathcal{D}_\blacktriangleright(FX, FY; FZ)$ ; then

$$f' = F\langle f, g \rangle(\text{id}_{FX}, \langle \rangle) = F\langle f, g \rangle(F\text{id}_X, F\langle \rangle) = F(\langle f, g \rangle(\text{id}_X, \langle \rangle)) = Ff$$

so that in fact  $F = (F_-)_\blacktriangleright$ , where  $F_- : \mathcal{C} \rightarrow \mathcal{D}$  is the “underlying” functor. We say that  $\mathcal{M}$  is “sequential” if it is isomorphic to some  $\mathcal{C}_\blacktriangleright$ .

Sequential multicategories have an obvious natural symmetric structure which is preserved by any functor. Thus we also have an embedding  $(-)_\blacktriangleright : \mathbf{Cat} \rightarrow \mathbf{sMlt}$  which restricts to an equivalence  $\mathbf{Cat} \simeq \mathbf{Seq}$ , where  $\mathbf{Seq} \subseteq \mathbf{sMlt}$  is the full subcategory of sequential multicategories.

2.4. REMARK. Note that  $1_\blacktriangleright$  is terminal in **Mlt** and in **sMlt**. In fact, we will see in Corollary 3.10 that  $(-)_\blacktriangleright : \mathbf{Cat} \rightarrow \mathbf{sMlt}$  has both a left and a right adjoint, so that it preserves (co)limits. Recall that the categories  $\mathbf{Mlt}(1_\blacktriangleright, \mathcal{M})$  and  $\mathbf{sMlt}(1_\blacktriangleright, \mathcal{M})$  can be identified with the categories  $\mathbf{Mon}(\mathcal{M})$  and  $\mathbf{cMon}(\mathcal{M})$  of monoids and commutative monoids in  $\mathcal{M}$ , respectively. In particular, when  $\mathcal{M}$  is representable we find again the usual notion of (commutative) monoid in a (symmetric) monoidal category.

Note also that any full sub-multicategory  $\mathcal{N} \subseteq \mathcal{M}$  of a sequential multicategory is itself sequential (on the corresponding full subcategory of  $\mathcal{M}_-$ ).

2.5. **THE MONOIDAL EMBEDDING.** For a detailed account of the relationships between multicategories and monoidal categories we refer to [Hermida, 2000] and [Leinster, 2003]. Let us just recall the main points. An arrow  $A_1, \dots, A_n \rightarrow A$  in a multicategory  $\mathcal{M}$  is “preuniversal” if it gives a representation for the functor  $\mathcal{M}(A_1, \dots, A_n; -) : \mathcal{M}_- \rightarrow \mathbf{Set}$ ;  $\mathcal{M}$  is “representable” if for any  $A_1, \dots, A_n \in \mathcal{M}$  there is a preuniversal arrow  $A_1, \dots, A_n \rightarrow A$  and if preuniversal arrows are closed with respect to composition.

Equivalently,  $\mathcal{M}$  is representable if it has a representation in the following sense: to any  $A_1, \dots, A_n \in \mathcal{M}$  is assigned a “universal” arrow  $u_{A_1, \dots, A_n} : A_1, \dots, A_n \rightarrow A$  such that, for any double sequence  $A_{i1}, \dots, A_{im_i}$ , composition with  $u_{A_{i1}, \dots, A_{im_i}} : A_{i1}, \dots, A_{im_i} \rightarrow A_i$  yields (for any  $B \in \mathcal{M}$ ) a bijection  $\mathcal{M}(A_1, \dots, A_n, B) \rightarrow \mathcal{M}(A_{11}, \dots, A_{nm_n}, B)$ .

We denote by **Rep**  $\subset$  **Mlt** and **sRep**  $\subset$  **sMlt** the full subcategories of (symmetric) representable multicategories. When we will consider representable multicategories, we assume that a representation in the above sense is given.

2.6. **PROPOSITION.** **Rep** (**sRep**) is equivalent to the category of (symmetric) monoidal categories and lax monoidal functors.

**PROOF.** We just give an idea of the correspondence. As mentioned in the introduction, to any monoidal category  $\mathcal{C}$  there corresponds a multicategory  $\mathcal{C}_\otimes$ . Conversely, a representation for  $\mathcal{M}$  yields a tensor product for  $\mathcal{M}_-$ .

Since the arrows in a representable multicategory are generated by unary arrows and universal arrows, the conditions for  $F : \mathcal{M} \rightarrow \mathcal{N}$  to be a functor in **Mlt** correspond to the conditions for  $F_- : (\mathcal{M}_-, \mathbf{I}, \otimes) \rightarrow (\mathcal{N}_-, \mathbf{I}, \otimes)$  to be a monoidal functor:

1. preservation of composition of unary arrows corresponds the functoriality of  $F_-$ ;
2. the assignment of an image in  $\mathcal{N}$  to the universal arrows  $A, B \rightarrow A \otimes B$  in  $\mathcal{M}$  corresponds to the assignment of the arrows  $FA \otimes FB \rightarrow F(A \otimes B)$ ;
3. preservation of composition of unary with universal arrows corresponds to the naturality of  $FA \otimes FB \rightarrow F(A \otimes B)$ ;
4. preservation of composition of universal arrows corresponds essentially to the coherence conditions for a monoidal functor.

We so get in fact a 2-equivalence: the condition for  $\alpha_A : FA \rightarrow GA$  to be natural becomes, when  $\mathcal{M}, \mathcal{N} \in \mathbf{Rep}$ , the commutativity condition with respect to unary arrows (ordinary naturality) and with respect to universal arrows, giving the usual definition of monoidal natural transformation. ■

2.7. **POWERS OF MULTICATEGORIES.** If the power  $\mathcal{N}^{\mathcal{M}}$  does exist in **Mlt**, then its objects are the functors  $\mathcal{M}_- \rightarrow \mathcal{N}_-$ , while arrows  $F_1, \dots, F_n \rightarrow F$  are mappings

$$\mathcal{M}(A_1, \dots, A_n; A) \rightarrow \mathcal{N}(F_1 A_1, \dots, F_n A_n; FA)$$

that are natural in all the variables:

$$\mathcal{N}^{\mathcal{M}}(F_1, \dots, F_n; F) = \int_{A_1, \dots, A_n, A} \mathbf{Set}(\mathcal{M}(A_1, \dots, A_n; A), \mathcal{N}(F_1 A_1, \dots, F_n A_n; F A)) . \quad (1)$$

Indeed, for objects we have

$$\mathbf{Mlt}(1^-, \mathcal{N}^{\mathcal{M}}) \cong \mathbf{Mlt}(1^- \times \mathcal{M}, \mathcal{N}) \cong \mathbf{Mlt}((\mathcal{M}_-)^-, \mathcal{N}) \cong \mathbf{Mlt}(\mathcal{M}_-, \mathcal{N}_-),$$

while the  $n$ -ary arrows  $F_1, \dots, F_n \rightarrow F$  are given by those functors  $t^n \times \mathcal{M} \rightarrow \mathcal{N}$  which restrict to the given functors on the objects of  $t^n$  (the generic  $n$ -ary arrow). Thus (1) follows from the description of  $t^n \times \mathcal{M}$  as given (for  $n = 2$ ) in the proof of Proposition 2.8.

Since the adjunction  $(-)^- \dashv (-)_-$  satisfies the Frobenius law (see Remark 2.2) the underlying functor  $(-)_- : \mathbf{Mlt} \rightarrow \mathbf{Cat}$  preserves powers (as can be also easily seen directly from (1) when  $n = 1$ ).

**2.8. PROPOSITION.** *The exponentiable multicategories are the promonoidal ones. In particular, representable multicategories and sequential multicategories are exponentiable, while no unary non-empty multicategory  $\mathcal{C}^-$  is exponentiable.*

**PROOF.** Suppose first that  $\mathcal{M}$  is exponentiable and consider the pushout  $q$  of the generic 2-ary arrow  $t : X, Y \rightarrow Z$  with itself along  $X : 1^- \rightarrow t$  and  $Z : 1^- \rightarrow t$ . Thus  $q$  has three non-identity arrows:  $t$ ,  $t'$  and their composite  $t'' = t(t', Y) : U, V, Y \rightarrow Z$

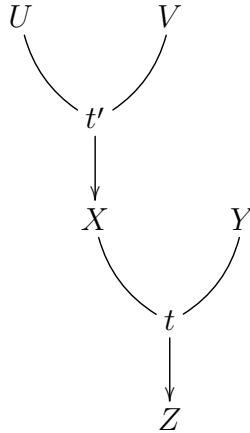

The product  $\mathcal{M} \times t$  consists of three copies of the unary  $(\mathcal{M}_-)^-$ , say  $\mathcal{M}_X$ ,  $\mathcal{M}_Y$  and  $\mathcal{M}_Z$ , an arrow  $f_t : A_X, B_Y \rightarrow C_Z$  for any 2-ary arrow  $f : A, B \rightarrow C$  in  $\mathcal{M}$  and the composition rule  $c_Z f_t(a_X, b_Y) = [c f(a, b)]_t$  for  $a : A' \rightarrow A$ ,  $b : B' \rightarrow B$  and  $c : C \rightarrow C'$ .

Similarly, the product  $\mathcal{M} \times q$  consists of five copies of the unary  $(\mathcal{M}_-)^-$ , say  $\mathcal{M}_X$ ,  $\mathcal{M}_Y$ ,  $\mathcal{M}_Z$ ,  $\mathcal{M}_U$  and  $\mathcal{M}_V$ , arrows  $f_t : A_X, B_Y \rightarrow C_Z$ ,  $f_{t'} : A_U, B_V \rightarrow C_X$  for any 2-ary arrow  $f : A, B \rightarrow C$  in  $\mathcal{M}$  and  $h_{t''} : A_U, B_V, C_Y \rightarrow D_Z$  for any 3-ary arrow  $h : A, B, C \rightarrow D$  in  $\mathcal{M}$ . The composition rules are as above and moreover  $f_t(g_{t'}, B_Y) = [f(g, B)]_{t''}$ , whenever the compositions are meaningful.

On the other hand, it is easy to see that the pushout  $\mathcal{M} \times t +_{\mathcal{M} \times 1^-} \mathcal{M} \times t$  (along the inclusion of  $\mathcal{M} \times 1^- = (\mathcal{M}_-)^-$  as  $\mathcal{M}_X$  and  $\mathcal{M}_Z$ ) consists of five copies of the unary  $(\mathcal{M}_-)^-$ ,



say  $\mathcal{M}_X, \mathcal{M}_Y, \mathcal{M}_Z, \mathcal{M}_U$  and  $\mathcal{M}_V$ , arrows  $f_t : A_X, B_Y \rightarrow C_Z$  and  $f_{t'} : A_U, B_V \rightarrow C_X$  for any 2-ary arrow  $f : A, B \rightarrow C$  in  $\mathcal{M}$  and formal composites  $f_t \circ g_{t'}$  (for  $f$  and  $g$  composable) with the associativity constraints  $f(a, B)_t \circ g_{t'} = f_t \circ (ag)_{t'}$  for any suitable unary arrow  $a$ .

Since  $\mathcal{M} \times -$  preserves colimits, the canonical  $\mathcal{M} \times t +_{\mathcal{M} \times 1} \mathcal{M} \times t \rightarrow \mathcal{M} \times q$  (sending  $f_t \circ g_{t'}$  in  $f_t(g_{t'}, B_Y)$  and obvious elsewhere) is an isomorphism. This amounts to saying that any  $h_{t''}$  actually has the form  $f_t(g_{t'}, B_Y)$  for  $f$  and  $g$  unique up to the above associativity constraints. Repeating the argumentation for the pushout of  $t$  with the generic 0-ary arrow, we get the other condition for a multicategory to be promonoidal (see [Day et al., 2005]).

In the other direction, suppose that  $\mathcal{M}$  is promonoidal. Let the multigraph  $\mathcal{N}^{\mathcal{M}}$  have the functors  $\mathcal{M}_- \rightarrow \mathcal{N}_-$  as objects and arrows in  $\mathcal{N}^{\mathcal{M}}(F_1, \dots, F_n; F)$  given by (1). Then we can define the composition of, say,  $\alpha : F, G \rightarrow H$  and  $\beta : H, L \rightarrow M$  as the mapping which takes a 3-ary arrow  $f : A, B, C \rightarrow D$  in  $\mathcal{M}$  to the arrow  $\beta_h(\alpha_g, LC) : FA, GB, LC \rightarrow MD$ , where  $h(g, C) = f$  is a decomposition of  $f$  given by the promonoidal structure of  $\mathcal{M}$ . Then it is straightforward to see that

1. the mapping does not depend on the particular decomposition (since two decompositions related by a unary arrow give the same result);
2. the mapping is natural;
3. the composition so defined on the multigraph  $\mathcal{N}^{\mathcal{M}}$  is associative and unitary;
4. the multicategory so obtained is indeed the power in **Mlt**.

■

Next we consider some relevant particular cases of powers.

2.9. MONOIDAL EXPONENTS. If  $\mathcal{M}$  is representable then for any  $\mathcal{N}$  the power  $\mathcal{N}^{\mathcal{M}}$  is given by

$$\begin{aligned} \mathcal{N}^{\mathcal{M}}(F_1, \dots, F_n; F) &= \int_{A_1, \dots, A_n, A} \mathbf{Set}(\mathcal{M}(A_1, \dots, A_n; A), \mathcal{N}(F_1 A_1, \dots, F_n A_n; FA)) = \\ &= \int_{A_1, \dots, A_n, A} \mathbf{Set}(\mathcal{M}(A_1 \otimes \dots \otimes A_n; A), \mathcal{N}(F_1 A_1, \dots, F_n A_n; FA)) = \\ &= \int_{A_1, \dots, A_n} \mathcal{N}(F_1 A_1, \dots, F_n A_n; F(A_1 \otimes \dots \otimes A_n)) \end{aligned}$$

which for  $\mathcal{N}$  also representable becomes

$$\mathcal{N}^{\mathcal{M}}(F_1, \dots, F_n; F) = \int_{A_1, \dots, A_n} \mathcal{N}(F_1 A_1 \otimes \dots \otimes F_n A_n; F(A_1 \otimes \dots \otimes A_n)).$$

Indeed, the monoids  $1_{\blacktriangleright} \rightarrow \mathcal{N}^{\mathcal{M}}$  on the object (functor)  $F : \mathcal{M}_- \rightarrow \mathcal{N}_-$  correspond to the lax monoidal structures for  $F$ .

2.10. **REMARK.** Monoids are included in **Cat** as one object categories  $\mathcal{C}$ ; thus they are also included in two ways in **Mlt**: as  $\mathcal{C}^-$  and as  $\mathcal{C}_\bullet$ . In fact, monoids are included in **Mlt** in a third way, namely as representable discrete multicategories (that is with a discrete underlying category). If  $\mathcal{M}$  and  $\mathcal{N}$  are monoids in the third sense,  $\mathcal{N}^{\mathcal{M}} \in \mathbf{Mlt}$  has all mappings of the underlying sets as objects and a (unique) arrow  $F, G \rightarrow H$  when  $(Fx) \cdot (Gy) = H(x \cdot y)$  (and  $H$  is the codomain of a 0-ary arrow if, and only if,  $H1 = 1$ ).

2.11. **MONOIDAL BASE.** Now we show that Day convolution is nothing but the monoidal structure on  $\mathcal{N}^{\mathcal{M}}$ , when  $\mathcal{N}$  is representable and cocomplete.

2.12. **PROPOSITION.** *If  $\mathcal{N}$  is representable and cocomplete, then  $\mathcal{N}^{\mathcal{M}}$  is also representable (for any promonoidal  $\mathcal{M}$ ) by the usual convolution tensor product.*

**PROOF.**

$$\begin{aligned} \mathcal{N}^{\mathcal{M}}(F_1, \dots, F_n; F) &= \int_{A_1, \dots, A_n, A} \mathbf{Set}(\mathcal{M}(A_1, \dots, A_n; A), \mathcal{N}(F_1 A_1, \dots, F_n A_n; F A)) = \\ &= \int_{A_1, \dots, A_n, A} \mathbf{Set}(\mathcal{M}(A_1, \dots, A_n; A), \mathcal{N}(F_1 A_1 \otimes \dots \otimes F_n A_n; F A)) = \\ &= \int_{A_1, \dots, A_n, A} \mathcal{N}(\mathcal{M}(A_1, \dots, A_n; A) \cdot F_1 A_1 \otimes \dots \otimes F_n A_n; F A) = \\ &= \int_A \mathcal{N}\left(\int^{A_1, \dots, A_n} \mathcal{M}(A_1, \dots, A_n; A) \cdot F_1 A_1 \otimes \dots \otimes F_n A_n; F A\right). \end{aligned}$$

Thus the functor  $\int^{A_1, \dots, A_n} \mathcal{M}(A_1, \dots, A_n; -) \cdot F_1 A_1 \otimes \dots \otimes F_n A_n$  is a representing object for  $\mathcal{N}^{\mathcal{M}}(F_1, \dots, F_n; -)$ . ■

2.13. **SEQUENTIAL EXPONENTS.** When  $\mathcal{M}$  is sequential, formula (1) becomes

$$\int_{A_1, \dots, A_n, A} \mathbf{Set}(\mathcal{M}(A_1; A) \times \dots \times \mathcal{M}(A_n; A), \mathcal{N}(F_1 A_1, \dots, F_n A_n; F A))$$

which by Yoneda reduction gives

$$\mathcal{N}^{\mathcal{M}}(F_1, \dots, F_n; F) = \int_A \mathcal{N}(F_1 A, \dots, F_n A; F A). \tag{2}$$

Thus, an arrow  $\alpha : F_1, \dots, F_n \rightarrow F$  in  $\mathcal{N}^{\mathcal{M}}$  amounts to a family of arrows

$$\alpha_A : F_1 A, \dots, F_n A \rightarrow F A \quad (A \in \mathcal{M})$$

such that for any unary  $f : A \rightarrow B$  in  $\mathcal{M}$

$$(Ff)\alpha_A = \alpha_B(F_1 f, \dots, F_n f). \tag{3}$$

Indeed, in this case (as it happens for ordinary categories) the natural mappings  $\alpha : \mathcal{M}(A_1, \dots, A_n; A) \rightarrow \mathcal{N}(F_1 A_1, \dots, F_n A_n; F A)$  are in fact determined by the image of those of the form  $\langle \text{id}_X, \dots, \text{id}_X \rangle : X, \dots, X \rightarrow X$ , since for  $f_i : A_i \rightarrow A$  we have

$$\langle f_1, \dots, f_n \rangle = \langle \text{id}_A, \dots, \text{id}_A \rangle (f_1, \dots, f_n)$$

and these have to satisfy condition (3) since for any  $f : A \rightarrow B$

$$f\langle \text{id}_A, \dots, \text{id}_A \rangle = \langle \text{id}_B, \dots, \text{id}_B \rangle(f, \dots, f).$$

If furthermore  $\mathcal{N}$  is representable, one thus gets the following well-known particular case of the convolution product:

2.14. PROPOSITION. *If  $\mathcal{N}$  is representable then  $\mathcal{N}^{\mathcal{C}_\blacktriangleright}$  is also representable, in a pointwise way:*

$$\mathcal{N}^{\mathcal{C}_\blacktriangleright}(F_1, \dots, F_n; F) = \int_A \mathcal{N}(F_1 A \otimes \dots \otimes F_n A; F A).$$

■

Since **Seq** is equivalent to **Cat**, it is cartesian closed. Moreover, products and exponentials in **Seq** can be computed as in **Mlt**:

2.15. COROLLARY. *The discrete cocones functor  $(-)_\blacktriangleright : \mathbf{Cat} \rightarrow \mathbf{Mlt}$  preserves products and exponentials. Thus **Seq** is closed with respect to products and exponentials in **Mlt**.*

PROOF. Since  $(-)_\blacktriangleright$  clearly preserves products, we need to show that  $\mathcal{D}^{\mathcal{C}_\blacktriangleright} \cong (\mathcal{D}^{\mathcal{C}})_\blacktriangleright$ . By the above description, an arrow  $F_1, \dots, F_n \rightarrow F$  in  $\mathcal{D}^{\mathcal{C}_\blacktriangleright}$  is a sequence of arrows  $\alpha_A^i : F_i A \rightarrow F A$ , for any  $A \in \mathcal{C}$ , such that

$$(Ff)\alpha_A^i = \alpha_B^i(F_i f)$$

for any  $f : A \rightarrow B$  in  $\mathcal{C}$ . But this amounts exactly to a sequence of natural transformations  $\alpha^i : F_i \rightarrow F$ , that is to an arrow in  $(\mathcal{D}^{\mathcal{C}})_\blacktriangleright$ . ■

2.16. POWERS OF SYMMETRIC MULTICATEGORIES. Powers in **sMlt** are computed essentially as in **Mlt**. Let  $\mathcal{M}, \mathcal{N} \in \mathbf{sMlt}$  and suppose that the power  $\mathcal{N}^{\mathcal{M}}$  of the underlying multicategories exists in **Mlt**. By (1), an arrow  $\alpha : F_1, \dots, F_n \rightarrow F$  is given by natural mappings  $\alpha : \mathcal{M}(A_1, \dots, A_n; A) \rightarrow \mathcal{N}(F_1 A_1, \dots, F_n A_n; F A)$ . If we define

$$\sigma\alpha : f \mapsto \sigma\alpha(\sigma^{-1}f) \tag{4}$$

it is easy to see that  $\sigma\alpha$  is also natural and that we so get a symmetric structure on  $\mathcal{N}^{\mathcal{M}}$ .

2.17. PROPOSITION. *In the above hypothesis,  $\mathcal{N}^{\mathcal{M}}$  with the symmetric structure given by (4) is also the power in **sMlt**.*

PROOF. A functor  $\alpha : \mathcal{L} \rightarrow \mathcal{N}^{\mathcal{M}}$  in **sMlt** is a functor  $\alpha : \mathcal{L} \rightarrow \mathcal{N}^{\mathcal{M}}$  in **Mlt** such that, for any  $g$  in  $\mathcal{L}$  and any permutation  $\sigma$  of its domain,  $\alpha(\sigma g) = \sigma(\alpha g)$ , that is

$$\alpha(\sigma g) : f \mapsto \sigma\alpha(\sigma^{-1}f) \iff \alpha(\sigma g) : \sigma f \mapsto \sigma(\alpha f).$$

When transposed,  $\alpha$  corresponds thus to a functor  $\bar{\alpha} : \mathcal{L} \times \mathcal{M} \rightarrow \mathcal{N}$  such that

$$\bar{\alpha}(\sigma g, \sigma f) = \sigma\bar{\alpha}(g, f)$$

that is to a functor  $\bar{\alpha} : \mathcal{L} \times \mathcal{M} \rightarrow \mathcal{N}$  in **sMlt**. ■

Thus, promonoidal symmetric multicategories are exponentiable in **sMlt**. We have seen in Section 2.13 that the  $\alpha : \mathcal{M}(A_1, \dots, A_n; A) \rightarrow \mathcal{N}(F_1 A_1, \dots, F_n A_n; FA)$  in  $\mathcal{N}^{\mathcal{C}}$  are in fact determined by the  $\alpha_A = \alpha(\text{id}_A, \dots, \text{id}_A)$ . Since the arrows  $\langle \text{id}_A, \dots, \text{id}_A \rangle$  in  $\mathcal{C}$  are fixed by any permutation of the domain, the formula (4) gives

$$(\sigma\alpha)_A = \sigma\alpha_A. \tag{5}$$

### 3. The monoidal closed structure of the category of symmetric multicategories

In the previous section we have studied the cartesian structure of **Mlt** and **sMlt**. We now consider a non-cartesian symmetric monoidal closed structure

$$(\mathbf{sMlt}, 1^-, \otimes_{BV})$$

on symmetric multicategories; the symmetry hypothesis is necessary. The Boardman-Vogt tensor product  $\otimes_{BV}$  is described in [Weiss, 2011], [Moerdijk & Weiss, 2007] and [Trova, 2010] and has its roots in [Boardman & Vogt, 1973] but also (for the one-sorted case) in the Kronecker tensor product of Lawvere theories of [Freyd, 1966]. The set of objects of  $\mathcal{M} \otimes_{BV} \mathcal{N}$  (or simply  $\mathcal{M} \otimes \mathcal{N}$ ) is the product of those of  $\mathcal{M}$  and  $\mathcal{N}$  while its arrows are generated by the arrows

$$f_X : \langle A_1, X \rangle, \dots, \langle A_n, X \rangle \rightarrow \langle A, X \rangle \quad ; \quad h_A : \langle A, X_1 \rangle, \dots, \langle A, X_m \rangle \rightarrow \langle A, X \rangle$$

(for any  $f : A_1, \dots, A_n \rightarrow A$  in  $\mathcal{M}$  and  $X \in \mathcal{N}$ , and any  $h : X_1, \dots, X_m \rightarrow X$  in  $\mathcal{N}$  and  $A \in \mathcal{M}$  respectively) with the obvious relations ensuring that we have functors in **sMlt**

$$(-)_X : \mathcal{M} \rightarrow \mathcal{M} \otimes \mathcal{N} \quad ; \quad (-)_A : \mathcal{N} \rightarrow \mathcal{M} \otimes \mathcal{N}$$

and a commuting relation for any pair of arrows  $f : A_1, \dots, A_n \rightarrow A$  in  $\mathcal{M}$  and  $h : X_1, \dots, X_m \rightarrow X$  in  $\mathcal{N}$ :

$$f_X(h_{A_1}, \dots, h_{A_n}) = \sigma h_A(f_{X_1}, \dots, f_{X_m})$$

where  $\sigma$  is the obvious permutation. For instance, if  $f : A, B, C \rightarrow D$  and  $h : X, Y \rightarrow Z$ , one has the following equality in  $\mathcal{M} \otimes \mathcal{N}$ :

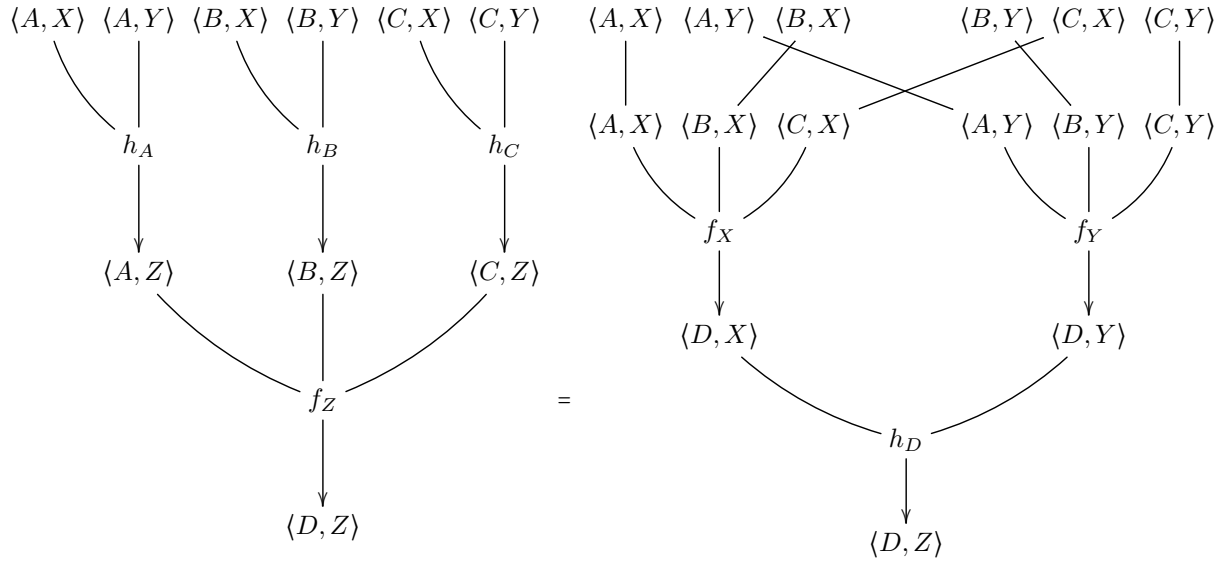

The associated internal hom  $[\mathcal{M}, \mathcal{N}]$  has functors  $\mathcal{M} \rightarrow \mathcal{N}$  as objects while an arrow  $\alpha : F_1, \dots, F_n \rightarrow F$  consists of arrows  $\alpha_A : F_1 A, \dots, F_n A \rightarrow F A$  ( $A \in \mathcal{M}$ ) such that the following commuting condition holds for any arrow  $f : A_1, \dots, A_m \rightarrow A$  in  $\mathcal{M}$ :

$$Ff(\alpha_{A_1}, \dots, \alpha_{A_m}) = \sigma \alpha_A(F_1 f, \dots, F_n f) \tag{6}$$

where  $\sigma$  is the obvious permutation. The composition and the symmetric structure are defined pointwise.

3.1. REMARK. The multicategory  $[\mathcal{M}, \mathcal{N}]$  is studied in [Tronin, 2011], where its arrows are called natural multitransformations (of multifunctors). Note that

$$[\mathcal{M}, \mathcal{N}]_- \cong \mathbf{sMlt}(\mathcal{M}, \mathcal{N})$$

where  $\mathbf{sMlt}$  is given the usual 2-category structure. Furthermore,

$$[\mathcal{C}^-, \mathcal{D}^-] \cong (\mathcal{D}^c)^- .$$

For instance, an arrow  $\alpha : F, G \rightarrow H$  is a family of arrows  $\alpha_A : FA, GA \rightarrow HA$  ( $A \in \mathcal{M}$ ) such that for any arrow, say  $f : A, B, C \rightarrow D$ , the following equality holds:

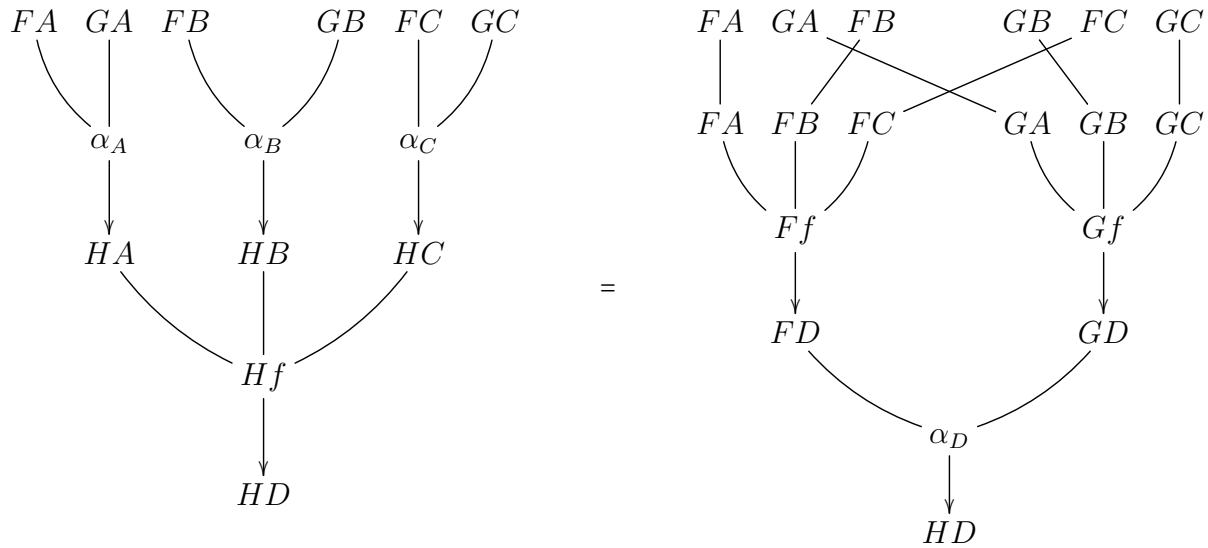

3.2. REMARK. In particular, if  $M, N, L : 1_{\blacktriangleright} \rightarrow \mathcal{M}$  are monoids on the objects  $A, B$  and  $C$  respectively, an arrow  $\alpha : M, N \rightarrow L$  in  $[1_{\blacktriangleright}, \mathcal{M}]$  is an arrow  $\alpha_{\star} : A, B \rightarrow C$  in  $\mathcal{M}$  such that

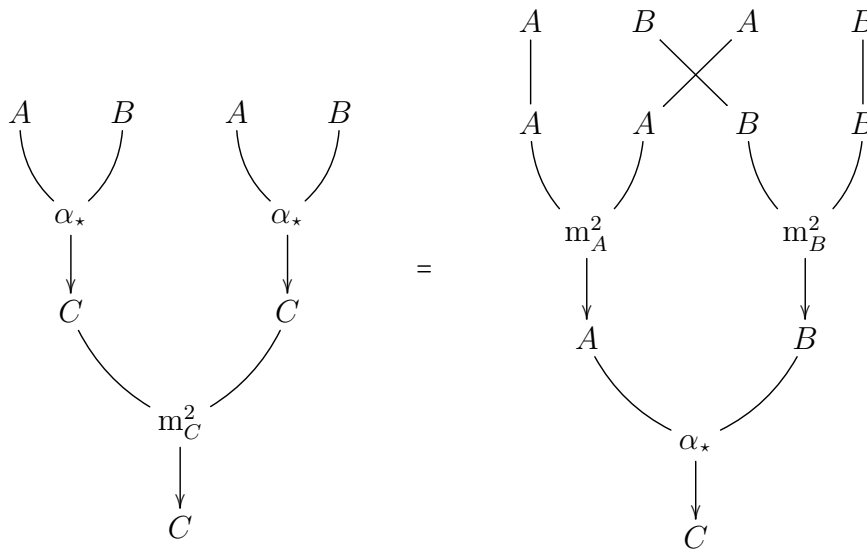

(where for instance  $m_A^2 = Mm^2$  is the image of the unique 2-ary arrow of  $1_\blacktriangleright$ ) and

$$\begin{array}{ccc}
 m_C^0 & & m_A^0 \quad m_B^0 \\
 \downarrow & & \downarrow \quad \downarrow \\
 C & = & A \quad B \\
 & & \searrow \quad \swarrow \\
 & & \alpha_* \\
 & & \downarrow \\
 & & C
 \end{array}$$

**3.3. PROPOSITION.** *For any  $\mathcal{C} \in \mathbf{Cat}$  and  $\mathcal{N} \in \mathbf{sMlt}$ ,*

$$[\mathcal{C}^-, \mathcal{N}] \cong \mathcal{N}^{\mathcal{C}\blacktriangleright} \quad ; \quad \mathcal{C}^- \otimes \mathcal{N} \cong \mathcal{C}\blacktriangleright \times \mathcal{N} .$$

*In particular,  $\mathcal{C}^- \otimes 1_\blacktriangleright \cong \mathcal{C}\blacktriangleright$  and  $\mathcal{C}^- \otimes \mathcal{D}^- \cong (\mathcal{C} \times \mathcal{D})^-$ .*

**PROOF.** Since  $\mathbf{sMlt}(\mathcal{C}^-, \mathcal{N}) \cong \mathbf{Cat}(\mathcal{C}, \mathcal{N}_-) \cong \mathbf{Cat}((\mathcal{C}\blacktriangleright)_-, \mathcal{N}_-)$ , the objects of  $[\mathcal{C}^-, \mathcal{N}]$  and of  $\mathcal{N}^{\mathcal{C}\blacktriangleright}$  are in both cases the functors  $\mathcal{C} \rightarrow \mathcal{N}_-$ .

Since the condition (6) relative to an arrow  $\alpha$  in  $[\mathcal{M}, \mathcal{N}]$  reduces, for the unary  $f$  in  $\mathcal{C}^-$ , to the condition (3) relative to an arrow  $\alpha$  in  $\mathcal{N}^{\mathcal{C}\blacktriangleright}$ , also the arrows coincide. Furthermore, by (5), the symmetric structure is the pointwise one in both cases. The second isomorphism then follows by adjunction.  $\blacksquare$

**3.4. COROLLARY.** *The 2-category  $\mathbf{sMlt}$  is tensored and cotensored (as a  $\mathbf{Cat}$ -enriched category). The tensor and the cotensor of  $\mathcal{M}$  by  $\mathcal{C} \in \mathbf{Cat}$  are given respectively by  $\mathcal{C}\blacktriangleright \times \mathcal{M}$  and  $\mathcal{M}^{\mathcal{C}\blacktriangleright}$ .*

**PROOF.**

$$\begin{aligned}
 \mathbf{sMlt}(\mathcal{C}\blacktriangleright \times \mathcal{M}, \mathcal{N}) &\cong \mathbf{sMlt}(\mathcal{C}^- \otimes \mathcal{M}, \mathcal{N}) \cong \mathbf{sMlt}(\mathcal{C}^-, [\mathcal{M}, \mathcal{N}]) \cong \\
 &\cong \mathbf{Cat}(\mathcal{C}, [\mathcal{M}, \mathcal{N}]_-) \cong \mathbf{Cat}(\mathcal{C}, \mathbf{sMlt}(\mathcal{M}, \mathcal{N})) .
 \end{aligned}$$

$$\begin{aligned}
 \mathbf{sMlt}(\mathcal{N}, \mathcal{M}^{\mathcal{C}\blacktriangleright}) &\cong \mathbf{sMlt}(\mathcal{N}, [\mathcal{C}^-, \mathcal{M}]) \cong \mathbf{sMlt}(\mathcal{C}^-, [\mathcal{N}, \mathcal{M}]) \cong \\
 &\cong \mathbf{Cat}(\mathcal{C}, [\mathcal{N}, \mathcal{M}]_-) \cong \mathbf{Cat}(\mathcal{C}, \mathbf{sMlt}(\mathcal{N}, \mathcal{M})) .
 \end{aligned}$$

(In fact, the proposition holds true in the non-symmetric context too.)  $\blacksquare$

3.5. CHARACTERIZATIONS OF SEQUENTIAL MULTICATEGORIES. We are now in a position to characterize sequential multicategories in a more abstract way. Following [Tronin, 2011], we define the *center* of  $\mathcal{M} \in \mathbf{sMlt}$  as the full sub-multicategory (in fact an operad) of  $[\mathcal{M}, \mathcal{M}]$  generated by the object  $\text{id}_{\mathcal{M}} : \mathcal{M} \rightarrow \mathcal{M}$ . Thus, an  $n$ -ary arrow  $\alpha$  in the center of  $\mathcal{M}$  consists of  $n$ -ary arrows  $\alpha_A : A, \dots, A \rightarrow A$  ( $A \in \mathcal{M}$ ) such that for each  $f : A_1, \dots, A_m \rightarrow A$

$$f(\alpha_{A_1}, \dots, \alpha_{A_m}) = \sigma \alpha_A(f, \dots, f).$$

Accordingly, a “central monoid” in  $\mathcal{M}$  is a commutative monoid in the center of  $\mathcal{M}$ , that is a functor  $1_{\blacktriangleright} \rightarrow [\mathcal{M}, \mathcal{M}]$  which restricts along  $1^- \rightarrow 1_{\blacktriangleright}$  to the name of the identity  $1^- \rightarrow [\mathcal{M}, \mathcal{M}]$ . Similarly one defines central unital magmas.

The functor  $1^- \rightarrow 1_{\blacktriangleright}$  induces canonical functors

$$[1_{\blacktriangleright}, \mathcal{M}] \rightarrow \mathcal{M} \quad ; \quad \mathcal{M} \rightarrow 1_{\blacktriangleright} \otimes \mathcal{M}.$$

The first one forgets the monoid structure while the second one inserts the arrow  $f \in \mathcal{M}$  in  $1_{\blacktriangleright} \otimes \mathcal{M}$  as  $f_*$  (where  $*$  is the unique object of  $1_{\blacktriangleright}$ ).

3.6. PROPOSITION. *The following are equivalent for  $\mathcal{M} \in \mathbf{sMlt}$ :*

1.  $\mathcal{M}$  is sequential, that is  $\mathcal{M} \cong \mathcal{C}_{\blacktriangleright}$ , for a  $\mathcal{C} \in \mathbf{Cat}$ .
2.  $\mathcal{M} \cong (\mathcal{M}_-)_{\blacktriangleright}$ .
3.  $\mathcal{M}$  has a central monoid  $1_{\blacktriangleright} \rightarrow [\mathcal{M}, \mathcal{M}]$ .
4.  $\mathcal{M}$  has a central unital magma.
5.  $[1_{\blacktriangleright}, \mathcal{M}] \rightarrow \mathcal{M}$  is an iso (that is  $\mathcal{M}$  is orthogonal to  $1^- \rightarrow 1_{\blacktriangleright}$  in an enriched sense).
6.  $\mathcal{M} \rightarrow 1_{\blacktriangleright} \otimes \mathcal{M}$  is an iso.

PROOF. Since  $(\mathcal{C}_{\blacktriangleright})_- = \mathcal{C}$ , (1) and (2) are equivalent. If  $[1_{\blacktriangleright}, \mathcal{M}] \rightarrow \mathcal{M}$  has an inverse  $\mathcal{M} \rightarrow [1_{\blacktriangleright}, \mathcal{M}]$ , one gets (by the closed structure of  $\mathbf{sMlt}$ ) a central monoid  $1_{\blacktriangleright} \rightarrow [\mathcal{M}, \mathcal{M}]$ . Thus (5)  $\Rightarrow$  (3), and similarly (6)  $\Rightarrow$  (3). The equivalence of (3) and (4) follows from a Hilton-Eckmann argument.

Suppose now that  $\mathcal{M}$  has a central monoid, given by  $n$ -ary arrows  $m_A^n : A, \dots, A \rightarrow A$ ,  $A \in \mathcal{M}$  and  $n = 0, 1, 2, \dots$ , such that for any  $f : A_1, \dots, A_m \rightarrow A$

$$f(m_{A_1}^n, \dots, m_{A_m}^n) = \sigma m_A^n(f, \dots, f)$$

(which implies in particular that any unary arrow is a monoid morphism). We will define identity-on-objects functors

$$F : \mathcal{M} \rightarrow (\mathcal{M}_-)_{\blacktriangleright} \quad ; \quad G : (\mathcal{M}_-)_{\blacktriangleright} \rightarrow \mathcal{M}$$



which are each other's inverse, thus proving that (3)  $\Rightarrow$  (2). For an arrow  $f : A_1, \dots, A_n \rightarrow A$  in  $\mathcal{M}$ , let  $Ff = \langle f_1, \dots, f_n \rangle$  in  $(\mathcal{M}_-)_\blacktriangleright$  be given by

$$f_i = f(m_{A_1}^0, m_{A_2}^0, \dots, m_{A_{i-1}}^0, A_i, m_{A_{i+1}}^0, \dots, m_{A_{n-1}}^0, m_{A_n}^0)$$

that is,  $f_i$  is obtained by substituting the 0-ary arrow  $m^0$  (the monoid unit) in any object of the domain but the  $i$ -th one.

In the other direction, if  $f_i : A_i \rightarrow A$  ( $i = 1, \dots, n$ ), let  $G\langle f_1, \dots, f_n \rangle = m_A^n(f_1, \dots, f_n)$ . Then one easily checks that  $F$  and  $G$  are indeed functors and that they are each other's inverse. For instance, for 2-ary arrows we have

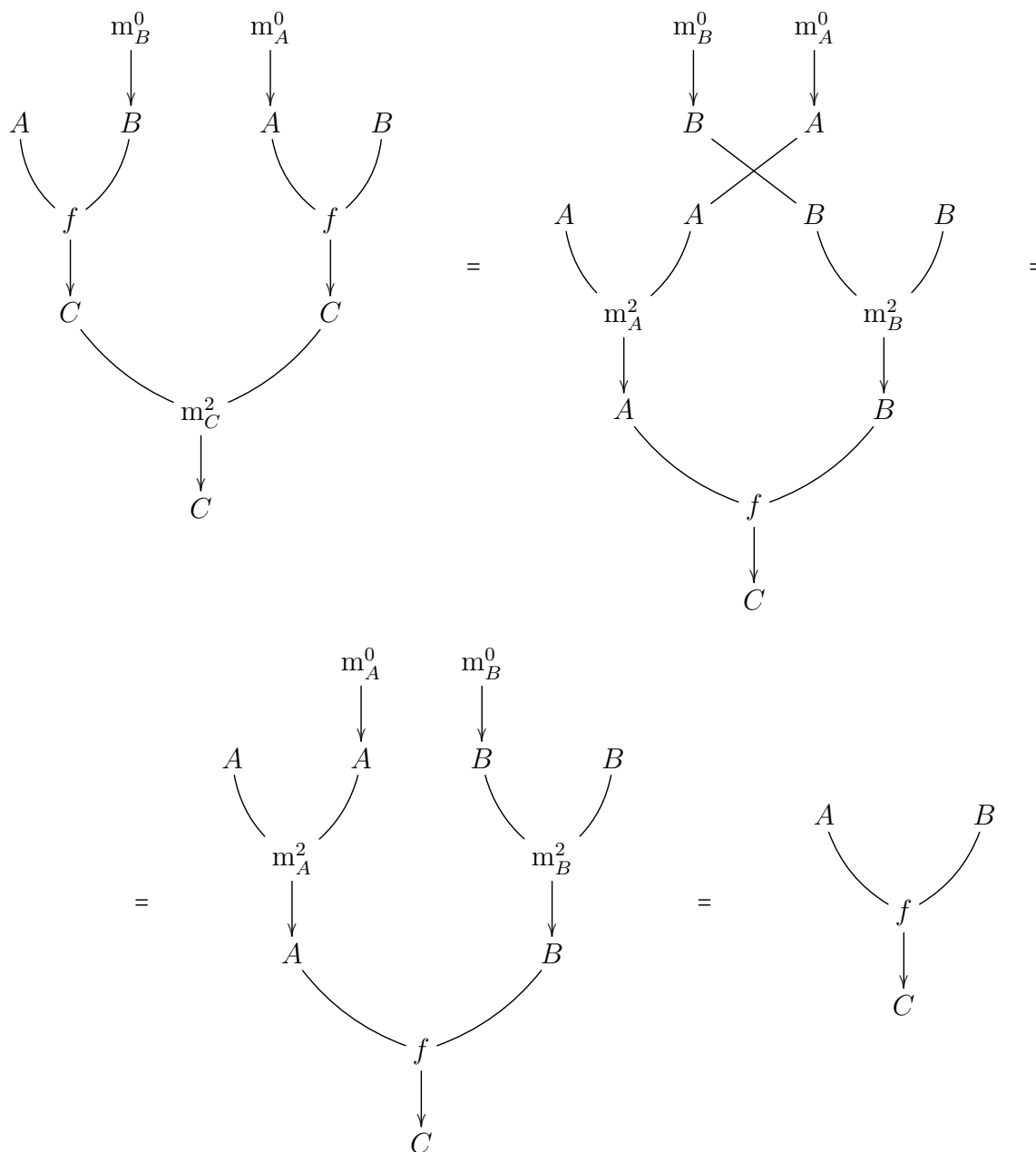

and in the other direction:

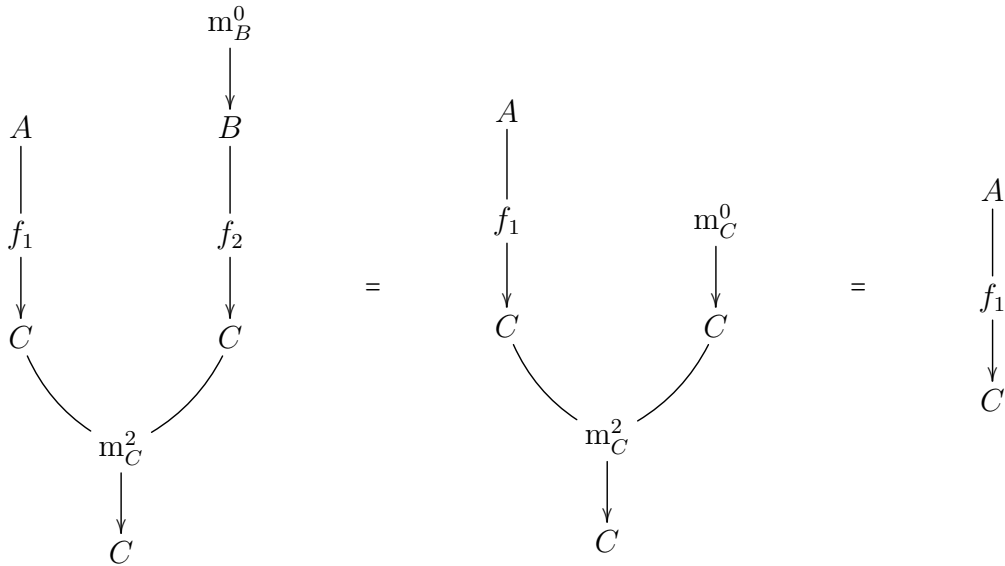

To prove that (1)  $\Rightarrow$  (5), note that  $m_A = \langle \text{id}_A, \dots, \text{id}_A \rangle$  is the unique monoid structure on  $A$  in  $\mathcal{C}_\bullet$ . Indeed, if for instance  $m_A^2 = \langle f, g \rangle$ , then  $f = m_A^2(\langle \rangle, \text{id}_A) = \text{id}_A$ . Furthermore,  $m_A$  clearly commutes with any arrow in  $\mathcal{C}_\bullet$ .

Finally, we prove that (1)  $\Rightarrow$  (6). Note first that for any  $\mathcal{M} \in \mathbf{sMlt}$ , by the definition of the Boardman-Vogt tensor product,  $1_\bullet \otimes \mathcal{M}$  has essentially the same objects as  $\mathcal{M}$ , while its arrows are generated by the  $f_\star$  (with  $f$  in  $\mathcal{M}$ ) and by the  $m_A^n : A, \dots, A \rightarrow A$  ( $A \in \mathcal{M}$ ), where  $m^n$  is the unique  $n$ -ary arrow in  $1_\bullet$ . These  $m_A^n$  form a commutative monoid on  $A$  and commute with all the  $f_\star$ . Thus  $m_A$  is a central monoid in  $1_\bullet \otimes \mathcal{M}$  and (since we already know that (3)  $\Rightarrow$  (1))  $1_\bullet \otimes \mathcal{M}$  is sequential. Now suppose that  $\mathcal{M}$  is itself sequential. To show that  $1_\bullet \otimes \mathcal{M} \cong \mathcal{M}$  it is enough to compare them with sequential multicategories  $\mathcal{L}$ :

$$\frac{\frac{1_\bullet \otimes \mathcal{M} \rightarrow \mathcal{L}}{\mathcal{M} \rightarrow [1_\bullet, \mathcal{L}]}}{\mathcal{M} \rightarrow \mathcal{L}}$$

(since we already know that (1)  $\Rightarrow$  (5)). ■

**3.7. COROLLARY.** *If  $\mathcal{L}$  is sequential and  $\mathcal{M} \in \mathbf{sMlt}$  then  $\mathcal{M} \otimes \mathcal{L}$ ,  $[\mathcal{M}, \mathcal{L}]$  and  $[\mathcal{L}, \mathcal{M}]$  are also sequential.*

**PROOF.**

$$(\mathcal{M} \otimes \mathcal{L}) \otimes 1_\bullet \cong \mathcal{M} \otimes (\mathcal{L} \otimes 1_\bullet) \cong \mathcal{M} \otimes \mathcal{L} ,$$

$$[1_\bullet, [\mathcal{M}, \mathcal{L}]] \cong [\mathcal{M}, [1_\bullet, \mathcal{L}]] \cong [\mathcal{M}, \mathcal{L}] ,$$

$$[1_{\blacktriangleright}, [\mathcal{L}, \mathcal{M}]] \cong [1_{\blacktriangleright} \otimes \mathcal{L}, \mathcal{M}] \cong [\mathcal{L}, \mathcal{M}] .$$

■

3.8. **REMARK.** Note that the central monoid in  $[\mathcal{M}, \mathcal{L}]$  is given by  $(m_F)_A = m_{FA}$ , while that in  $[\mathcal{L}, \mathcal{M}]$  is given by  $(m_F)_A = Fm_A$  (where  $m_A$  is the central monoid in  $\mathcal{L}$ ).

3.9. **COROLLARY.** *The functors  $1_{\blacktriangleright} \otimes -$  and  $[1_{\blacktriangleright}, -]$  give respectively a reflection and a coreflection of  $\mathbf{sMlt}$  in  $\mathbf{Seq}$ .*

**PROOF.** If  $\mathcal{L}$  is sequential, then for any  $\mathcal{M} \in \mathbf{sMlt}$  we have natural isomorphisms

$$\frac{1_{\blacktriangleright} \otimes \mathcal{M} \rightarrow \mathcal{L}}{\mathcal{M} \rightarrow [1_{\blacktriangleright}, \mathcal{L}]} \quad ; \quad \frac{\mathcal{L} \rightarrow [1_{\blacktriangleright}, \mathcal{M}]}{1_{\blacktriangleright} \otimes \mathcal{L} \rightarrow \mathcal{M}}$$

$$\mathcal{M} \rightarrow \mathcal{L} \qquad \qquad \mathcal{L} \rightarrow \mathcal{M}$$

■

3.10. **COROLLARY.**  $(-)_{\blacktriangleright} : \mathbf{Cat} \rightarrow \mathbf{sMlt}$  has both a left and a right adjoint.

**PROOF.** Just compose the above (co)reflection with an equivalence  $\mathbf{Cat} \simeq \mathbf{Seq}$ ; for instance:

$$(1_{\blacktriangleright} \otimes -)_- \dashv (-)_{\blacktriangleright} \dashv [1_{\blacktriangleright}, -]_- \cong \mathbf{cMon}(-) .$$

■

3.11. **REMARK.** The above results can be placed in a more general perspective. Consider a monoidal category  $(\mathcal{C}, \mathbf{I}, \otimes)$  with a terminal object  $1 \in \mathcal{C}$ . Then we have a (unique) monoid structure on  $1$  (with respect to  $\otimes$ ) and thus also a monad  $1 \otimes (-)$  on  $\mathcal{C}$ . For instance, for  $\mathcal{C} = (\mathbf{Set}, 0, +)$  one gets the monad for pointed sets.

If  $\mathcal{C}$  is closed, we have  $1 \otimes (-) \dashv [1, -]$ , so that  $[1, -]$  is a comonad on  $\mathcal{C}$  with the same algebras. Suppose furthermore that  $1 \otimes 1 \rightarrow 1$  is an iso. Then the (co)monad is idempotent and the isomorphic categories of algebras isolate a full subcategory  $\mathcal{D} \subseteq \mathcal{C}$  which is both reflective and coreflective.

When  $\mathcal{C} = \mathbf{sMlt}$  we get  $\mathcal{D} \cong \mathbf{Seq} \simeq \mathbf{Cat}$ . For another instance, consider the poset  $\mathcal{C}$  of the subsets of a monoid  $M$  with the usual tensor (truth values convolution on the discrete  $M$ ). Then  $\mathcal{D}$  is given by the monoid ideals of  $M$ . (Note that if  $\mathcal{C}$  is cartesian or  $\mathbf{I} \cong 1$  one gets  $\mathcal{D} \cong \mathcal{C}$ , while for pointed sets or abelian groups  $\mathcal{D} \subseteq \mathcal{C}$  is the zero object inclusion.)

3.12. **COROLLARY.**

$$(\mathcal{C} \times \mathcal{D})_{\blacktriangleright} \cong \mathcal{C}_{\blacktriangleright} \otimes \mathcal{D}_{\blacktriangleright} \quad ; \quad (\mathcal{D}^{\mathcal{C}})_{\blacktriangleright} \cong [\mathcal{C}_{\blacktriangleright}, \mathcal{D}_{\blacktriangleright}] .$$

(Recall however that  $1_{\blacktriangleright} \neq \mathbf{I} = 1^-$ .)

PROOF.

$$\mathcal{C}_\blacktriangleright \otimes \mathcal{D}_\blacktriangleright \cong (\mathcal{C}^- \otimes 1_\blacktriangleright) \otimes \mathcal{D}_\blacktriangleright \cong \mathcal{C}^- \otimes (1_\blacktriangleright \otimes \mathcal{D}_\blacktriangleright) \cong \mathcal{C}^- \otimes \mathcal{D}_\blacktriangleright \cong \mathcal{C}_\blacktriangleright \times \mathcal{D}_\blacktriangleright .$$

$$[\mathcal{C}_\blacktriangleright, \mathcal{D}_\blacktriangleright] \cong [\mathcal{C}^- \otimes 1_\blacktriangleright, \mathcal{D}_\blacktriangleright] \cong [\mathcal{C}^-, [1_\blacktriangleright, \mathcal{D}_\blacktriangleright]] \cong [\mathcal{C}^-, \mathcal{D}_\blacktriangleright] \cong \mathcal{D}_\blacktriangleright^{\mathcal{C}^-} .$$

■

3.13. REMARK. In the same way one sees that, for any  $\mathcal{M} \in \mathbf{sMlt}$ ,

$$\mathcal{C}_\blacktriangleright \otimes \mathcal{M} \cong \mathcal{C}_\blacktriangleright \times (\mathcal{M} \otimes 1_\blacktriangleright) \quad ; \quad [\mathcal{C}_\blacktriangleright, \mathcal{M}] \cong [1_\blacktriangleright, \mathcal{M}]^{\mathcal{C}_\blacktriangleright} \quad ; \quad [\mathcal{M}, \mathcal{C}_\blacktriangleright] \cong \mathcal{C}_\blacktriangleright^{\mathcal{M} \otimes 1_\blacktriangleright} .$$

3.14. COROLLARY. *By restricting  $\otimes$  and  $[-, -]$  to  $\mathbf{Seq} \subset \mathbf{sMlt}$  one gets a monoidal closed structure  $(\mathbf{Seq}, 1_\blacktriangleright, \otimes)$  which is cartesian and coincides essentially with the cartesian closed structure on  $\mathbf{Cat}$ .*

■

3.15. SEQUENTIALITY AND REPRESENTABILITY. In the rest of this section we investigate some consequences of the previous results, under the hypothesis that some of the multicategories involved are representable. We begin by recalling what are the sequential representable categories.

3.16. PROPOSITION. *The full sub-multicategory  $\mathbf{sRep} \cap \mathbf{Seq} \subset \mathbf{sMlt}$  is equivalent to the category of cocartesian monoidal categories (those in which  $I$  is initial and  $\otimes$  gives sums) and to the category of categories with finite sums (and all functors).*

PROOF. Indeed, a preuniversal arrow  $A_1, \dots, A_n \rightarrow A$  in  $\mathcal{C}_\blacktriangleright$  amounts to a representation for the functor  $\mathcal{C}(A_1, -) \times \dots \times \mathcal{C}(A_n, -)$ , that is to a universal cone  $A_i \rightarrow A_1 + \dots + A_n$ . Furthermore, universal cones are closed with respect to composition and all functors between finite sum categories are lax monoidal functors between the corresponding cocartesian monoidal categories.

■

Next, there is the fact that representability is inherited pointwise by  $[\mathcal{M}, \mathcal{N}]$  from  $\mathcal{N}$ .

3.17. PROPOSITION. *If  $\mathcal{N}$  is representable then so is  $[\mathcal{M}, \mathcal{N}]$ , for any  $\mathcal{M} \in \mathbf{sMlt}$ .*

PROOF. For simplicity, we focus on 2-ary arrows. Given  $F, G : \mathcal{M} \rightarrow \mathcal{N}$  we want to find a universal arrow  $u : F, G \rightarrow H$  in  $[\mathcal{M}, \mathcal{N}]$ . Let  $u_A : FA, GA \rightarrow HA$  ( $A \in \mathcal{M}$ ) be universal in  $\mathcal{N}$ . Since we want to extend the assignment  $A \mapsto HA$  to a functor  $H : \mathcal{M} \rightarrow \mathcal{N}$  in such a way that the  $u_A$  become an arrow in  $[\mathcal{M}, \mathcal{N}]$ , the effect of  $H$  on arrows is forced by the naturality conditions. Namely, for  $f : A_1, \dots, A_n \rightarrow A$  in  $\mathcal{M}$ , the condition (6)

$$Hf(u_{A_1}, \dots, u_{A_n}) = \sigma u_A(Ff, Gf)$$

defines (by the universality of the  $u_A$ ) a unique arrow  $Hf$  in  $\mathcal{N}$ . For instance, given the arrow  $f : A, B \rightarrow C$  in  $\mathcal{M}$ ,  $Hf$  is defined by

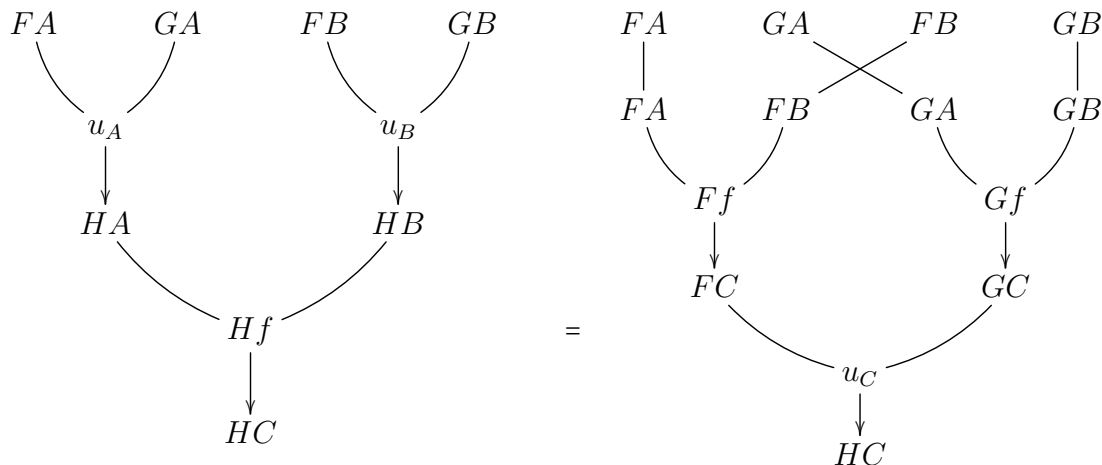

Now, drawing suitable diagrams, it is routine to check that  $H$  is indeed a functor. For instance, let us show that  $H$  preserves composition of 2-ary arrows:

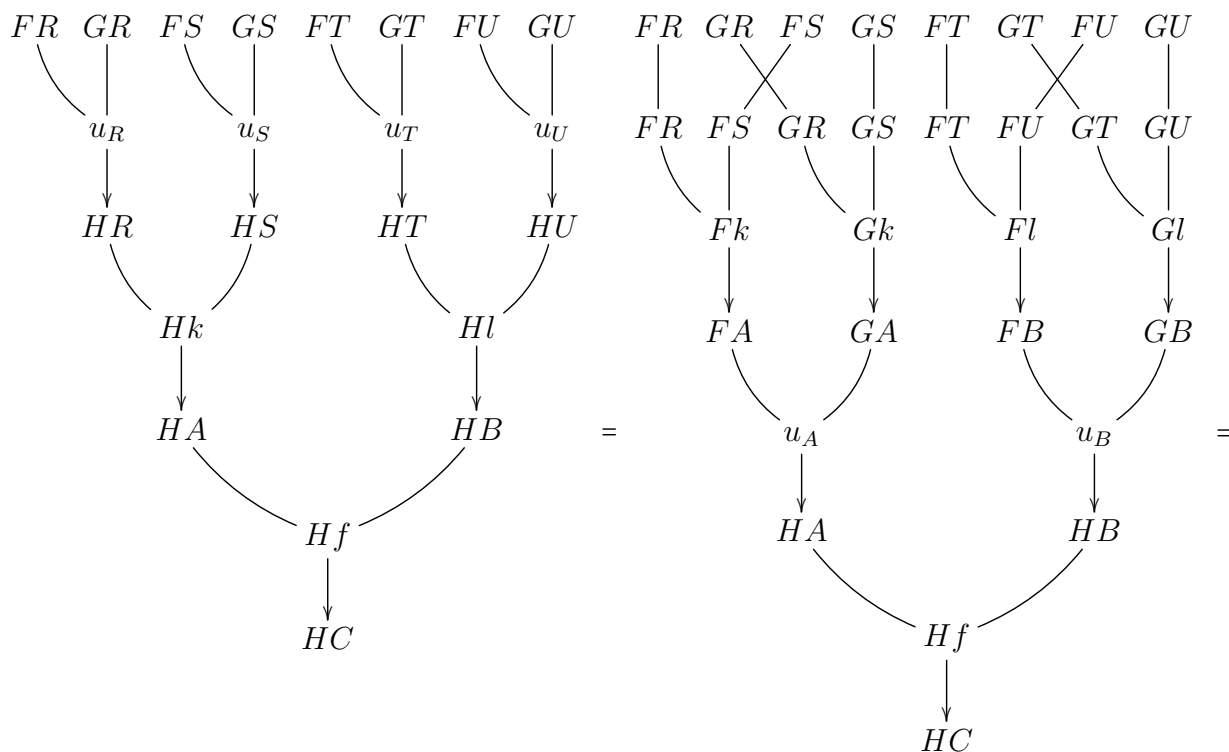

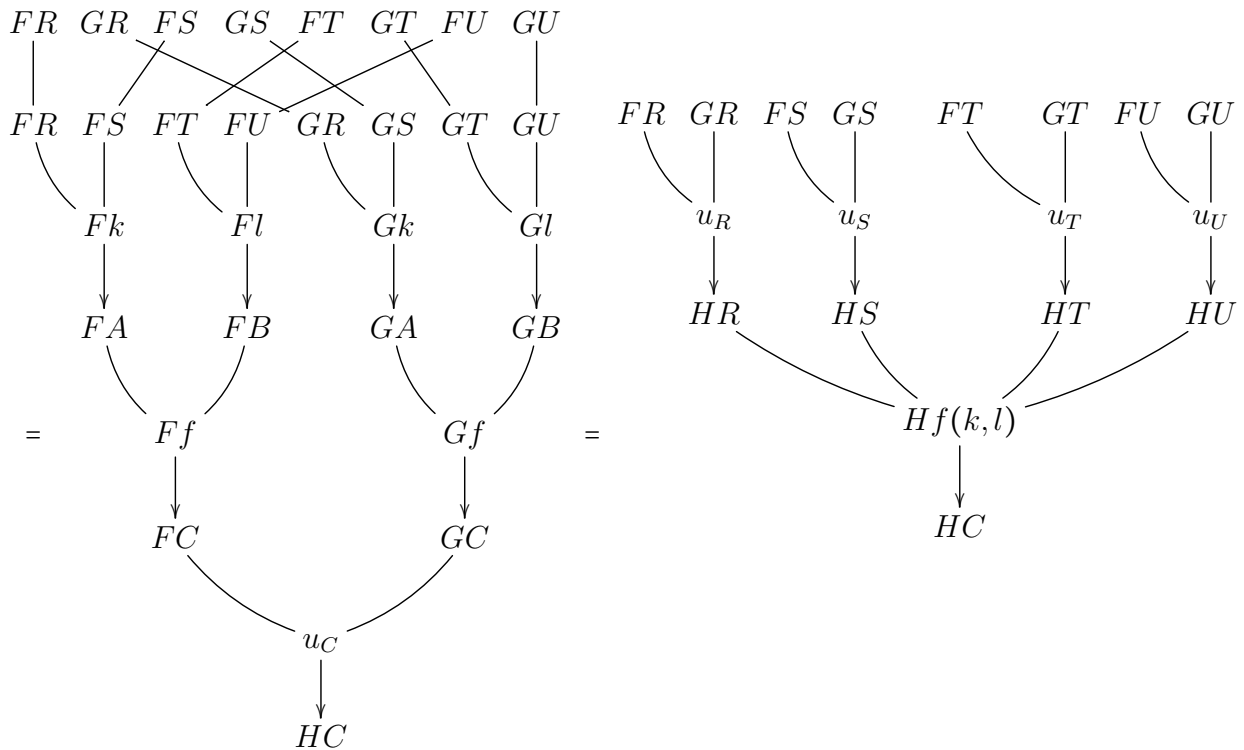
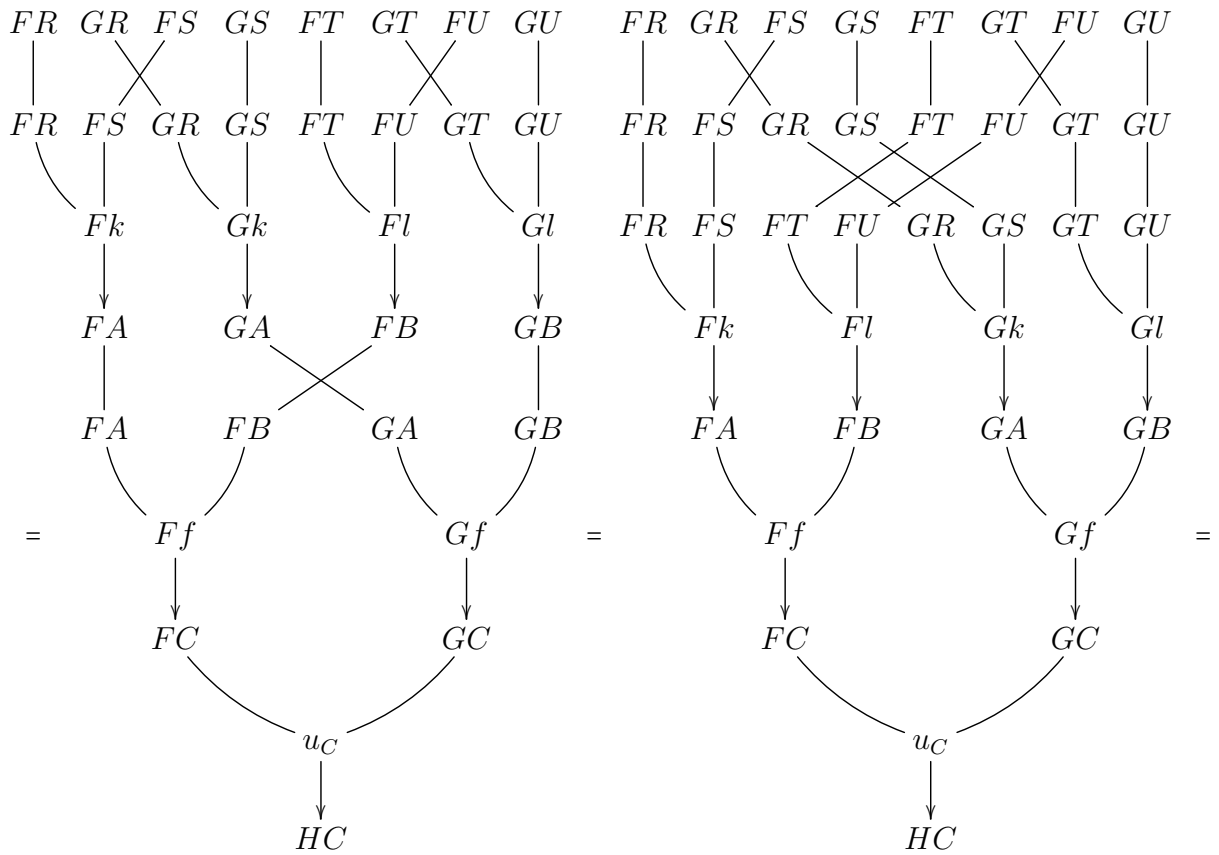

Now, it is clear that if  $t : F, G \rightarrow L$  factors in  $[\mathcal{M}, \mathcal{N}]$  as  $t = ul$  then  $l$  is uniquely defined by  $t_A = u_A l_A$ . Then, to show that  $u : F, G \rightarrow H$  is universal we need to check that  $l_A : HA \rightarrow LA$  so defined is indeed a map in  $[\mathcal{M}, \mathcal{N}]$ , that is (for 2-ary arrows, for simplicity) that  $Lf(l_A, l_B) = l_C Hf$ , for any  $f : A, B \rightarrow C$ :

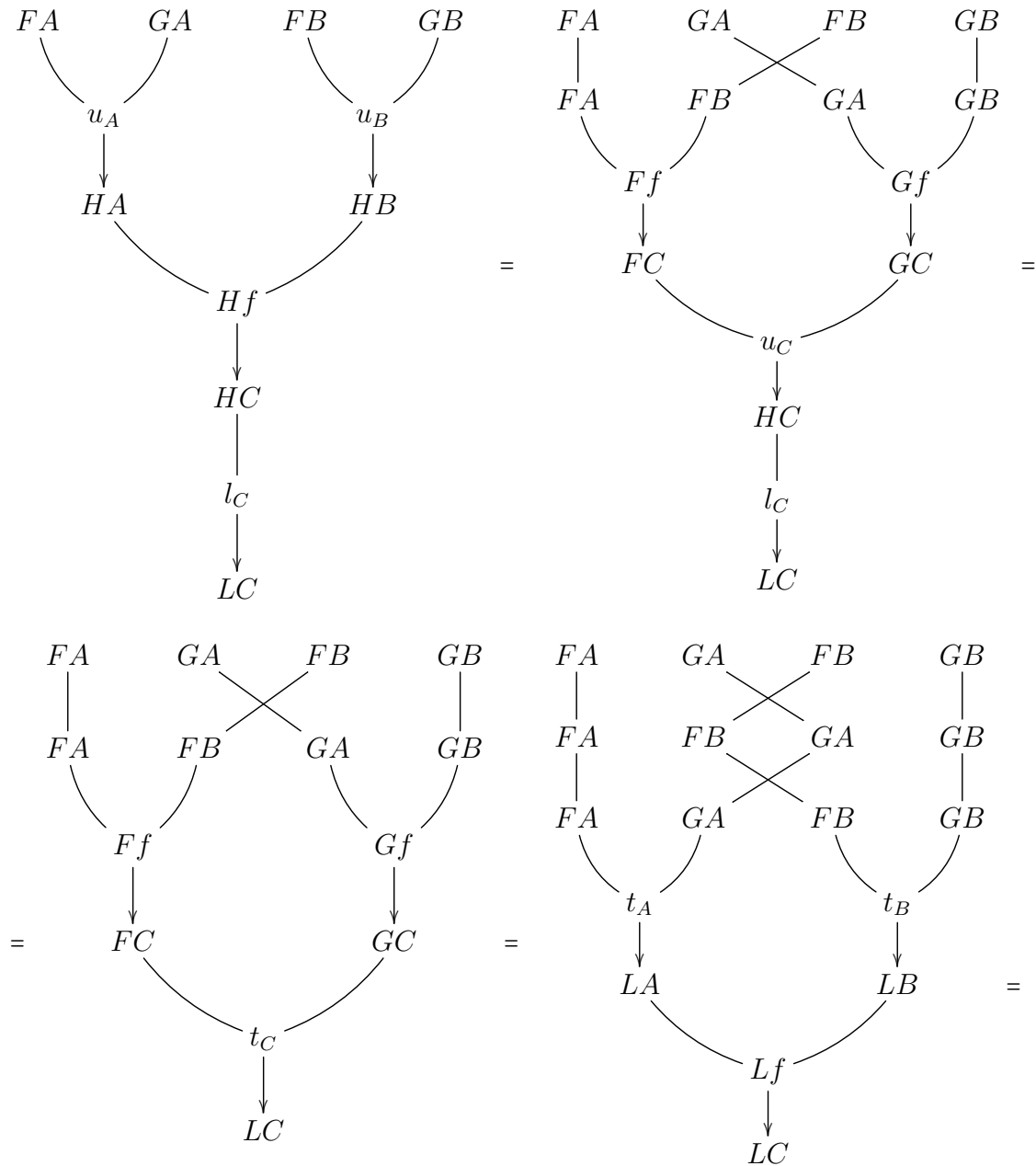

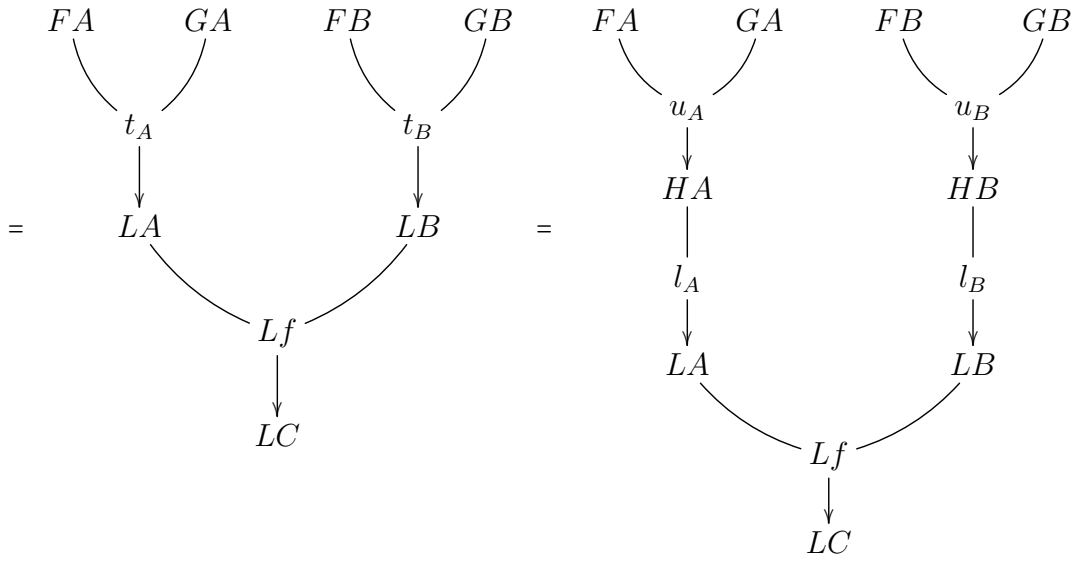

■

3.18. REMARK. In particular, for  $\mathcal{M} = \mathbf{1}_\bullet$ , one gets the usual monoidal structure on  $\mathbf{cMon}(\mathcal{N}) = [1_\bullet, \mathcal{N}]_-$ . More specifically, let  $M, N : \mathbf{1}_\bullet \rightarrow \mathcal{N}$  be monoids on the objects  $A$  and  $B$  respectively, and let  $u : A, B \rightarrow A \otimes B$  be universal in  $\mathcal{N}$ . Then  $u$  is universal in  $[1_\bullet, \mathcal{N}]$  as well, when  $A \otimes B$  is given the monoid structure such that

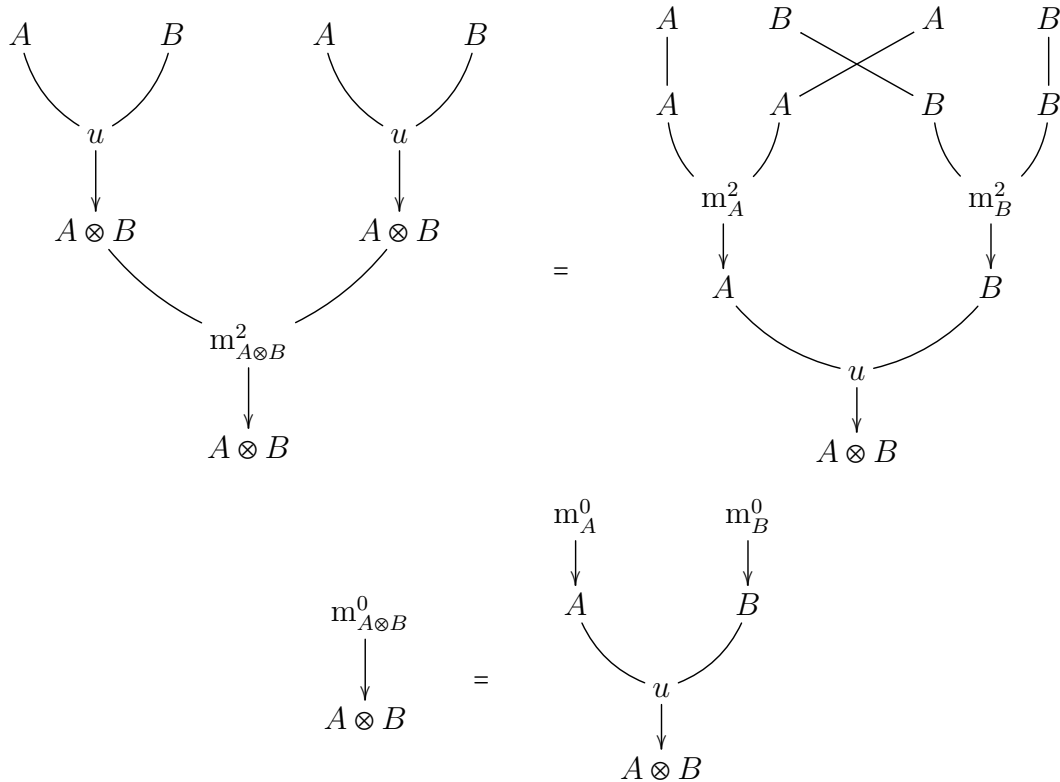



Similarly, a 0-ary  $u : \rightarrow I$  universal in  $\mathcal{N}$  is universal also in  $[1_{\blacktriangleright}, \mathcal{N}]$ , when  $I$  is given the monoid structure such that  $m_1^2(u, u) = u = m_1^0$ .

Now, from Corollary 3.9 and propositions 3.16 and 3.17 we get

**3.19. COROLLARY.** *The coreflection of  $\mathbf{sMlt}$  in  $\mathbf{Seq}$  restricts to  $\mathbf{sRep} \subset \mathbf{sMlt}$ . Thus the commutative monoids construction  $\mathbf{cMon}(-) = [1_{\blacktriangleright}, -]_-$  gives the coreflection of symmetric monoidal categories in the cocartesian ones. ■*

(In [Fox, 1976] a similar result is stated, but with strict in place of lax monoidal functors.) In particular,

**3.20. COROLLARY.** *If  $\mathcal{M}$  is representable, then the category  $\mathbf{cMon}(\mathcal{M})$  of commutative monoids in  $\mathcal{M}$ , with the tensor product of Remark 3.18, is cocartesian. ■*

So, cocartesian symmetric monoidal categories  $(\mathcal{C}, I, \otimes)$  can be characterized as those of the form  $\mathcal{C} \cong \mathbf{cMon}(\mathcal{D})$  for a symmetric monoidal  $(\mathcal{D}, I, \otimes)$ , or also as those for which  $\mathbf{cMon}(\mathcal{C}) \rightarrow \mathcal{C}$  is an iso. In fact, propositions 3.6 and 3.16 yield a more effective characterization, namely as those monoidal categories with a central monoid (or unital magma). The latter amounts to a monoid (or unital magma)  $m_A$  on each object  $A \in \mathcal{C}$ , which commutes with both unary and universal arrows (since these generate the corresponding multicategory  $\mathcal{C}_{\otimes}$ ). The first condition says that each arrow is a monoid (or unital magma) morphism, that is that the  $m_A^0$  and the  $m_A^2$  are natural. The second one says that the monoid (unital magma) structure  $m_{A \otimes B}$  on  $A \otimes B$  is the expected one, related as in Remark 3.18 to  $m_A$  and  $m_B$  (and similarly for  $m_I$ ). Thus, we find again the following piece of folklore:

**3.21. PROPOSITION.** *A symmetric monoidal category  $(\mathcal{C}, I, \otimes)$  is cocartesian if, and only if, it has a natural monoid (or unital magma) structure  $m_A$  ( $A \in \mathcal{C}$ ) such that  $m_{A \otimes B}$  is related in the usual way with  $m_A$  and  $m_B$ . ■*

## 4. Cartesian multicategories and preadditive categories

The algebra of abstract operations encoded in a (small) multicategory  $\mathcal{M}$  can be seen as an algebraic theory, whose category of models is  $\mathbf{Mlt}(\mathcal{M}, \mathbf{Set}_\times)$ . The algebraic theories which can be so represented are those which can be given by equations between terms with the same variables in the same order (named “strongly regular” in [Leinster, 2003]). Notably, the terminal multicategory is the theory for monoids. In order to allow permutation (exchange) of variables (as for commutative monoids) one considers symmetric multicategories instead.

More general algebraic theories, such as the theory of groups, require laws which can be expressed in multicategories of the form  $\mathcal{C}_\times$  (for a finite product category  $\mathcal{C}$ ) where one can furthermore duplicate or delete the variables. For instance, given an operation  $f : A \times B \times A \rightarrow D$  in  $\mathbf{Set}$ , one gets another operation  $\sigma f : B \times C \times A \rightarrow D$  by

$$\sigma f(b, c, a) = f(a, b, a) .$$

It is convenient to see the domain of  $f$  as the family of sets  $\mathbf{3} = \{1, 2, 3\} \rightarrow \text{obj Set}$  given by  $1 \mapsto A, 2 \mapsto B, 3 \mapsto A$ , that of  $\sigma f$  as the family of sets  $\mathbf{3} \rightarrow \text{obj Set}$  given by  $1 \mapsto B, 2 \mapsto C, 3 \mapsto A$  and  $\sigma : 1 \mapsto 3, 2 \mapsto 1, 3 \mapsto 3$  as a family morphism (that is a mapping  $\mathbf{3} \rightarrow \mathbf{3}$  over  $\text{obj Set}$ ).

More generally, if  $A_1, \dots, A_n$  and  $B_1, \dots, B_m$  are families of objects in  $\mathcal{C}$  and  $\sigma : \mathbf{n} \rightarrow \mathbf{m}$  is a map of families in the above sense, one gets (for each  $C \in \mathcal{C}$ ) a mapping

$$\sigma(-) : \mathcal{C}(A_1 \times \dots \times A_n, C) \rightarrow \mathcal{C}(B_1 \times \dots \times B_m, C)$$

by precomposing with the map  $\bar{\sigma} : B_1 \times \dots \times B_m \rightarrow A_1 \times \dots \times A_n$  such that  $p_i \bar{\sigma} = q_{\sigma i}$ . As particular instances of  $\bar{\sigma}$  we find projections and diagonals.

Abstracting from this, one gets the notion of cartesian multicategory defined below and the 2-category **fpMlt** of cartesian multicategories.

Thus the categories **Mlt**, **sMlt** and **fpMlt** can be seen as the “doctrines” of strongly regular, linear and algebraic theories respectively, and the latter has the same expressive power of (many-sorted) Lawvere theories. Since the obvious forgetful functors have left adjoints (see [Gould, 2008]) each doctrine “contains” the weaker ones. For instance, one has an algebraic theory for commutative monoids by taking the free algebraic theory on  $\mathbf{1}_\bullet \in \mathbf{sMlt}$ , which is  $\mathbf{N}_\bullet \in \mathbf{fpMlt}$  (the sequential multicategory on the monoid of natural numbers with the cartesian structure given by zero and addition).

4.1. **CARTESIAN MULTICATEGORIES.** Cartesian multicategories have appeared in various guises in the literature; when considered in relation with deduction theory they are usually called “Gentzen multicategories” (see for instance [Lambek, 1989]). The definition that we give here follows essentially [Boardman & Vogt, 1973] and [T. Fiore, 2005] (see also [Gould, 2008], especially for the case of operads).

Let  $\mathbf{N}$  be the full subcategory of **Set** which has objects  $\mathbf{0}, \mathbf{1}, \mathbf{2}, \dots$ , with  $\mathbf{n} = \{1, 2, \dots, n\}$  (so that  $\mathbf{0} = \emptyset$ ) and consider, for a multicategory  $\mathcal{M}$ , the obvious comma category  $\mathbf{N}/\text{obj } \mathcal{M}$ . Now, the domain of an  $n$ -ary arrow in  $\mathcal{M}$  is in fact a mapping  $\alpha : \mathbf{n} \rightarrow \text{obj } \mathcal{M}$ , that is an object of  $\mathbf{N}/\text{obj } \mathcal{M}$ ; thus, for any fixed codomain object  $A \in \mathcal{M}$  we have a mapping

$$\text{obj}(\mathbf{N}/\text{obj } \mathcal{M}) \rightarrow \text{obj Set} \quad ; \quad \alpha \mapsto \mathcal{M}(\alpha; A) = \mathcal{M}(A_1, \dots, A_n; A) .$$

To give a cartesian structure on  $\mathcal{M}$  means to extend these mappings to functors

$$\mathbf{N}/\text{obj } \mathcal{M} \rightarrow \mathbf{Set}$$

in a way that is compatible with composition.

To illustrate such functoriality and compatibility conditions and to do calculations in cartesian multicategories, it is convenient to make use of a graphical calculus (which in fact we have already used in the particular case of symmetric multicategories). For instance, if  $f : X, Y, X \rightarrow U$  is an arrow in  $\mathcal{M}$  and  $\sigma$  is the following mapping in  $\mathbf{N}/\text{obj } \mathcal{M}$

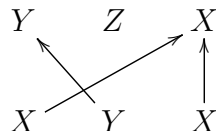

we have the arrow  $\sigma f : Y, Z, X \rightarrow U$  which we denote by

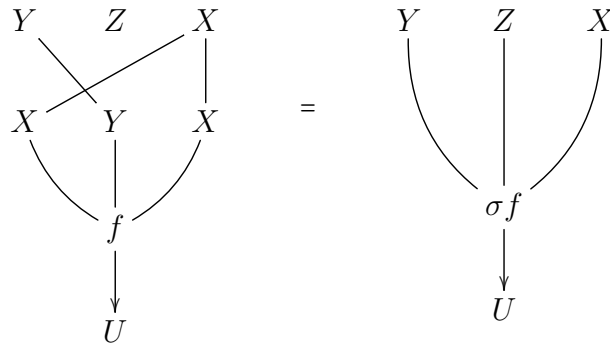

Functoriality (that is the fact that mappings over  $\text{obj } \mathcal{M}$  act on hom-sets)

$$\rho(\sigma f) = (\rho\sigma)f$$

is illustrated by the fact that we can compose mappings over arrows. For instance,

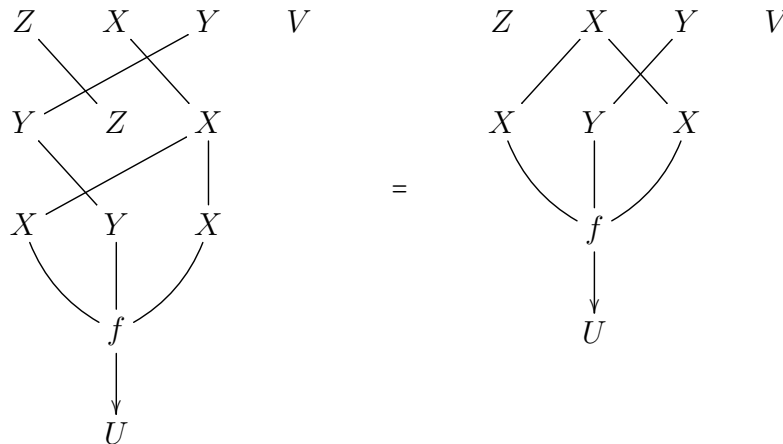

As for the compatibility conditions with respect to composition, there are two of them. The first one is pretty obvious:

$$f(\sigma_1 f_1, \dots, \sigma_n f_n) = (\sigma_1 + \dots + \sigma_n)f(f_1, \dots, f_n)$$

that is, composing  $f$  with arrows  $f_i$  acted upon by  $\sigma_i$  is the same as composing  $f$  with the  $f_i$  and then acting on it with the obvious “sum” of maps in  $\mathbf{N}/\text{obj } \mathcal{M}$ . Thus, diagrams

such as this one

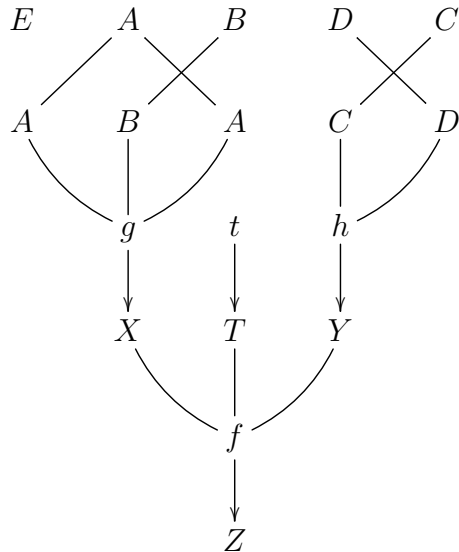

can be interpreted in an unambiguous way in a cartesian multicategory.

The second compatibility condition concerns composition in the case when it is  $f$  that is acted upon by a mapping  $\sigma$ :

$$(\sigma f)(f_1, \dots, f_n) = \sigma'(f(f_{\sigma_1}, \dots, f_{\sigma_n}))$$

where  $\sigma'$  is a suitably defined map in  $\mathbf{N}/\text{obj } \mathcal{M}$ , which is graphically obvious. For instance,

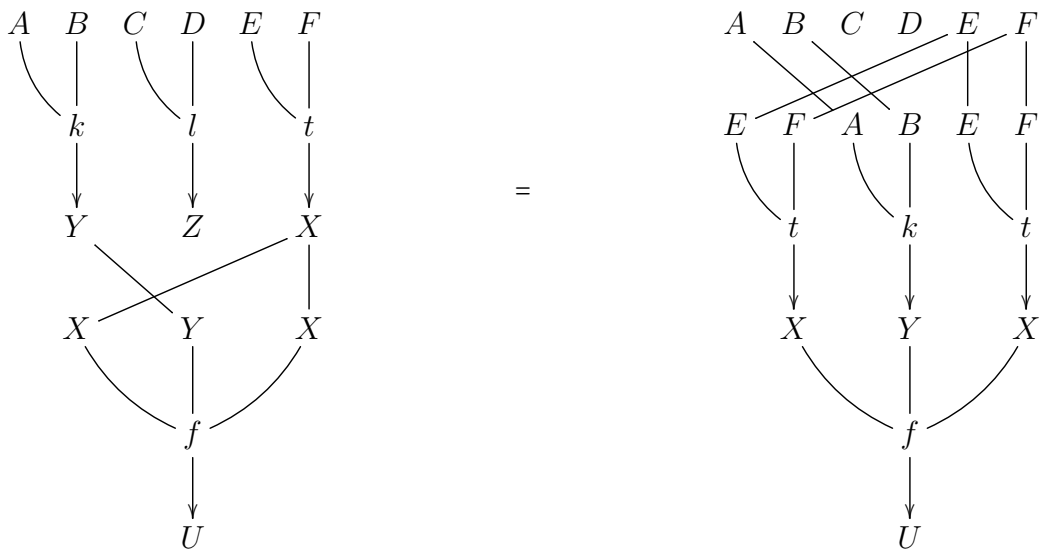

A functor  $F : \mathcal{M} \rightarrow \mathcal{M}'$  induces an obvious functor  $\mathbf{N}/\text{obj } \mathcal{M} \rightarrow \mathbf{N}/\text{obj } \mathcal{M}'$ , and maps of cartesian multicategories are of course those functors which commute with the actions of  $\mathbf{N}/\text{obj } \mathcal{M}$  and  $\mathbf{N}/\text{obj } \mathcal{M}'$ . For instance, for  $\sigma$  as above,

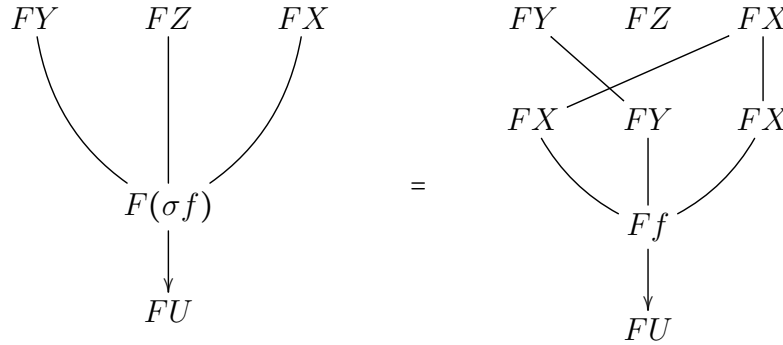

By defining 2-cells as in **sMlt**, we so obtain the 2-category **fpMlt** of cartesian multicategories, with the obvious forgetful functor  $U : \mathbf{fpMlt} \rightarrow \mathbf{sMlt}$ .

4.2. REMARK. An important special case are the actions of constant shape  $\mathbf{n} \rightarrow \mathbf{1}$ , giving “contraction” mappings on hom-sets:

$$\gamma_n : \mathcal{M}(A, \dots, A; B) \rightarrow \mathcal{M}(A; B) .$$

If  $\mathcal{M}$  is promonoidal, its cartesian structure is determined by its symmetric structure and by contractions. Indeed, any  $\sigma : \mathbf{m} \rightarrow \mathbf{n}$  can be written as a bijection followed by a monotone  $\sigma' : \mathbf{m} \rightarrow \mathbf{n}$ , and the latter is a sum of constant mappings  $\sigma'_1, \dots, \sigma'_n$ . Now, to know  $\sigma'f$  it is enough to write  $f$  as the composite  $f'(f_1, \dots, f_n)$  following the pattern of the  $\sigma'_n$  (using promonoidality) and then to contract the  $f_i$  (using the first compatibility condition). For instance,

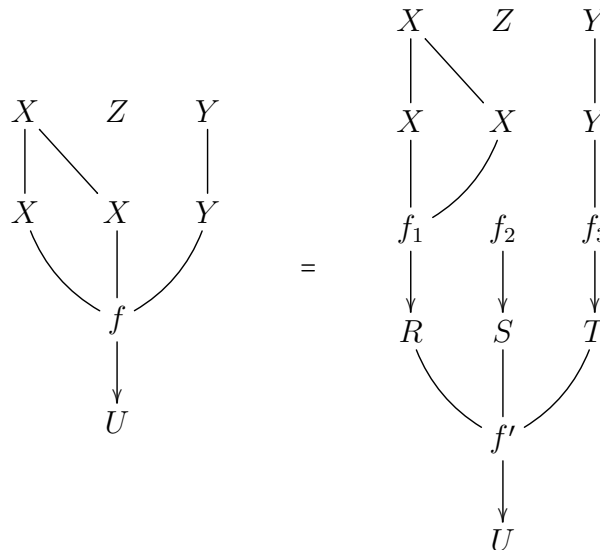

4.3. ALGEBRAIC PRODUCTS. Let  $\mathcal{M}$  be a cartesian multicategory. An algebraic product of  $A, B \in \mathcal{M}$  consists of an object  $C$  along with maps  $p : C \rightarrow A$ ,  $q : C \rightarrow B$  and  $u : A, B \rightarrow C$

such that

$$\begin{array}{c}
 C \\
 \swarrow \quad \searrow \\
 C \qquad C \\
 \downarrow p \quad \downarrow q \\
 A \qquad B \\
 \searrow \quad \swarrow \\
 u \\
 \downarrow \\
 C
 \end{array}
 =
 \begin{array}{c}
 C \\
 \downarrow \text{id} \\
 C
 \end{array}
 \tag{7}$$

$$\begin{array}{c}
 A \qquad B \\
 \searrow \quad \swarrow \\
 u \\
 \downarrow \\
 C \\
 \downarrow p \\
 A
 \end{array}
 =
 \begin{array}{c}
 A \qquad B \\
 \downarrow \text{id} \\
 A
 \end{array}
 \qquad
 \begin{array}{c}
 A \qquad B \\
 \searrow \quad \swarrow \\
 u \\
 \downarrow \\
 C \\
 \downarrow q \\
 B
 \end{array}
 =
 \begin{array}{c}
 A \qquad B \\
 \downarrow \text{id} \\
 B
 \end{array}
 \tag{8}$$

The definition easily extends to any finite family  $A_1, \dots, A_n$  of objects. In particular, for  $n = 0$ , an algebraic product of the empty family is an object  $C$  with a 0-ary arrow  $u : \rightarrow C$  such that

$$\begin{array}{c}
 C \\
 \downarrow u \\
 C
 \end{array}
 =
 \begin{array}{c}
 C \\
 \downarrow \text{id} \\
 C
 \end{array}$$

(On the left, the 0-ary  $u$  is acted upon by a map of shape  $\mathbf{0} \rightarrow \mathbf{1}$ .)

We say that the cartesian multicategory  $\mathcal{M}$  has algebraic products if any finite family of objects in  $\mathcal{M}$  has an algebraic product.

4.4. UNIVERSAL PRODUCTS. Let  $\mathcal{M}$  be a cartesian multicategory. A universal product of  $A, B \in \mathcal{M}$  consists of an object  $C$  along with maps  $p : C \rightarrow A$  and  $q : C \rightarrow B$  such that any pair of arrows  $f : X_1, \dots, X_n \rightarrow A$  and  $g : X_1, \dots, X_n \rightarrow B$  with the same domain factors uniquely as  $f = pt$  and  $g = qt$ .

The definition of course extends to any family of objects. In particular, a universal product of the empty family is an object  $C$  such that each hom-set  $\mathcal{M}(X_1, \dots, X_n; C)$  has a unique element.

4.5. PROPOSITION. *For any finite family  $A_1, \dots, A_n$  in a cartesian multicategory  $\mathcal{M}$ , the following are equivalent:*

1.  $A_1, \dots, A_n$  has an algebraic product.
2.  $A_1, \dots, A_n$  has a universal product.
3.  $A_1, \dots, A_n$  is the domain of a preuniversal arrow.

PROOF. We prove the case  $n = 2$ , the other ones being similar. To prove that (1) implies (3), we show that in an algebraic product  $p : C \rightarrow A$ ,  $q : C \rightarrow B$  and  $u : A, B \rightarrow C$ ,  $u$  is preuniversal; that is, that any arrow  $f : A, B \rightarrow D$  factors uniquely as  $f = tu$ . Indeed, if such a  $t : C \rightarrow D$  does exist, we have

$$\begin{array}{c} C \\ \downarrow \\ t \\ \downarrow \\ D \end{array} = \begin{array}{c} C \\ \swarrow \quad \searrow \\ C \quad C \\ \downarrow p \quad \downarrow q \\ A \quad B \\ \searrow \quad \swarrow \\ u \\ \downarrow \\ C \\ \downarrow \\ t \\ \downarrow \\ D \end{array} = \begin{array}{c} C \\ \swarrow \quad \searrow \\ C \quad C \\ \downarrow p \quad \downarrow q \\ A \quad B \\ \searrow \quad \swarrow \\ f \\ \downarrow \\ D \end{array}$$

thus showing unicity. Furthermore, this  $t$  gives indeed the desired factorization:

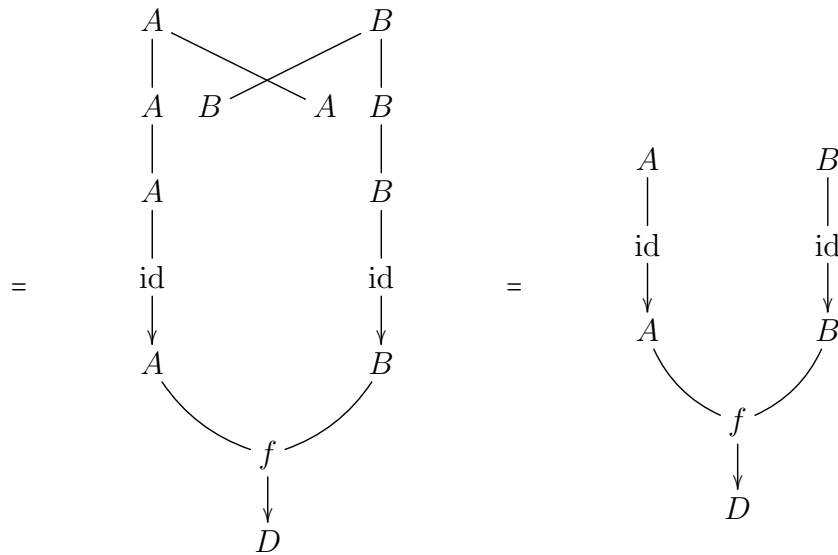
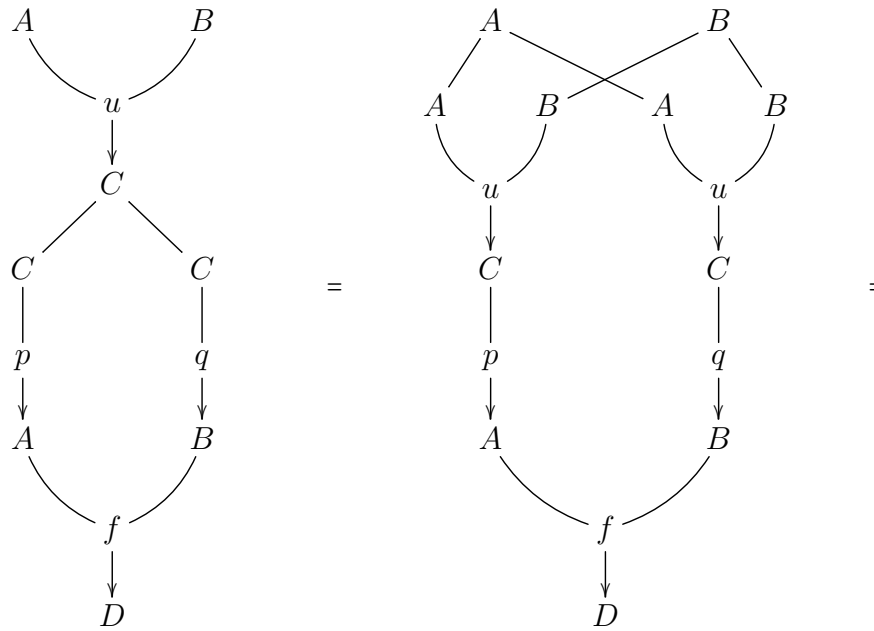

Similarly, to prove that (1) implies (2) we show that in an algebraic product  $p : C \rightarrow A$ ,  $q : C \rightarrow B$  and  $u : A, B \rightarrow C$ ,  $p$  and  $q$  are the projections for a universal product. Suppose that we have arrows (unary, for graphical simplicity)  $f : D \rightarrow A$  and  $f : D \rightarrow B$ . If they



factor as  $f = pt$  and  $g = qt$ , then  $t$  is equal to

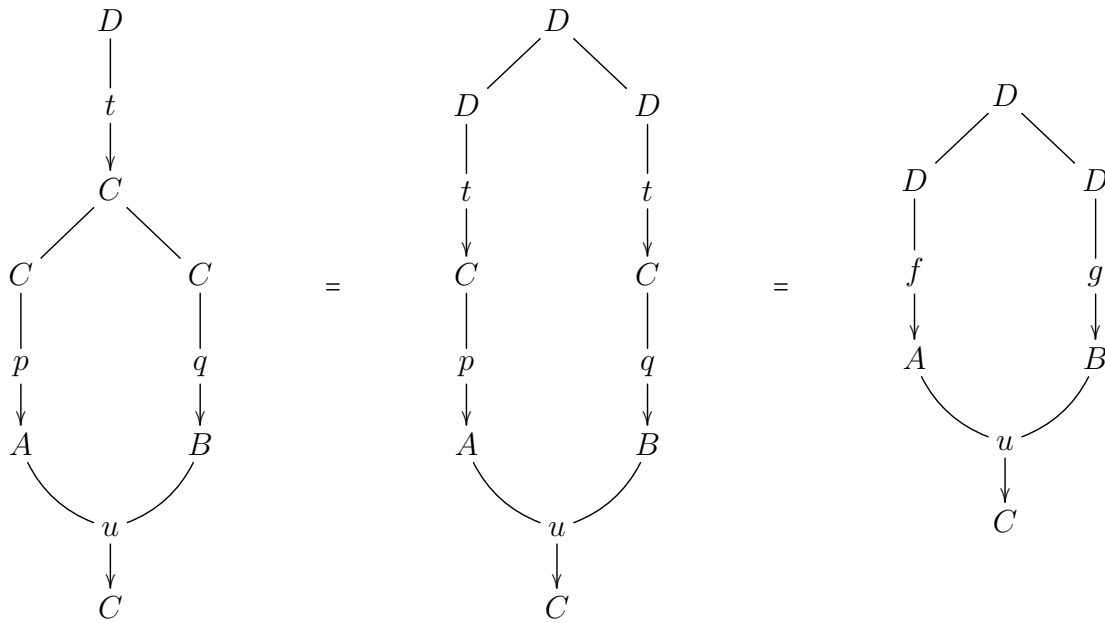

and this  $t$  gives indeed the desired factorization:

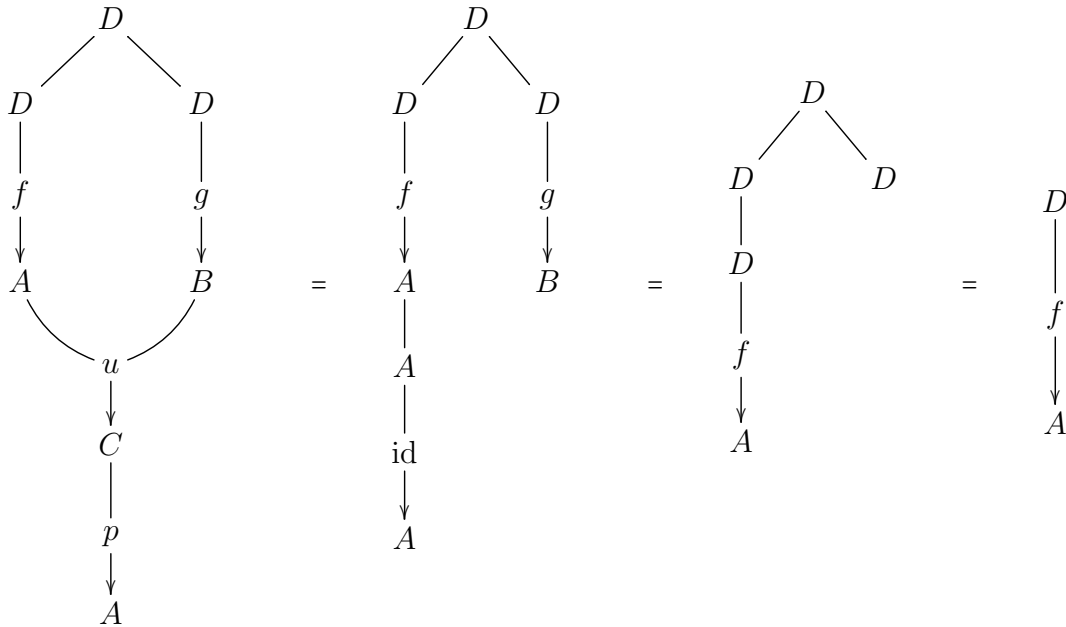

(and similarly  $qt = g$ ).

In the other direction, to show that (3) implies (1), suppose that  $u : A, B \rightarrow C$  is preuniversal and define  $p : C \rightarrow A$  and  $q : C \rightarrow B$  as the unique arrows fulfilling equations (8) in the definition of algebraic product. We so get indeed an algebraic product for  $A$

and  $B$ , since condition (7) follows again from the preuniversality of  $u$ :

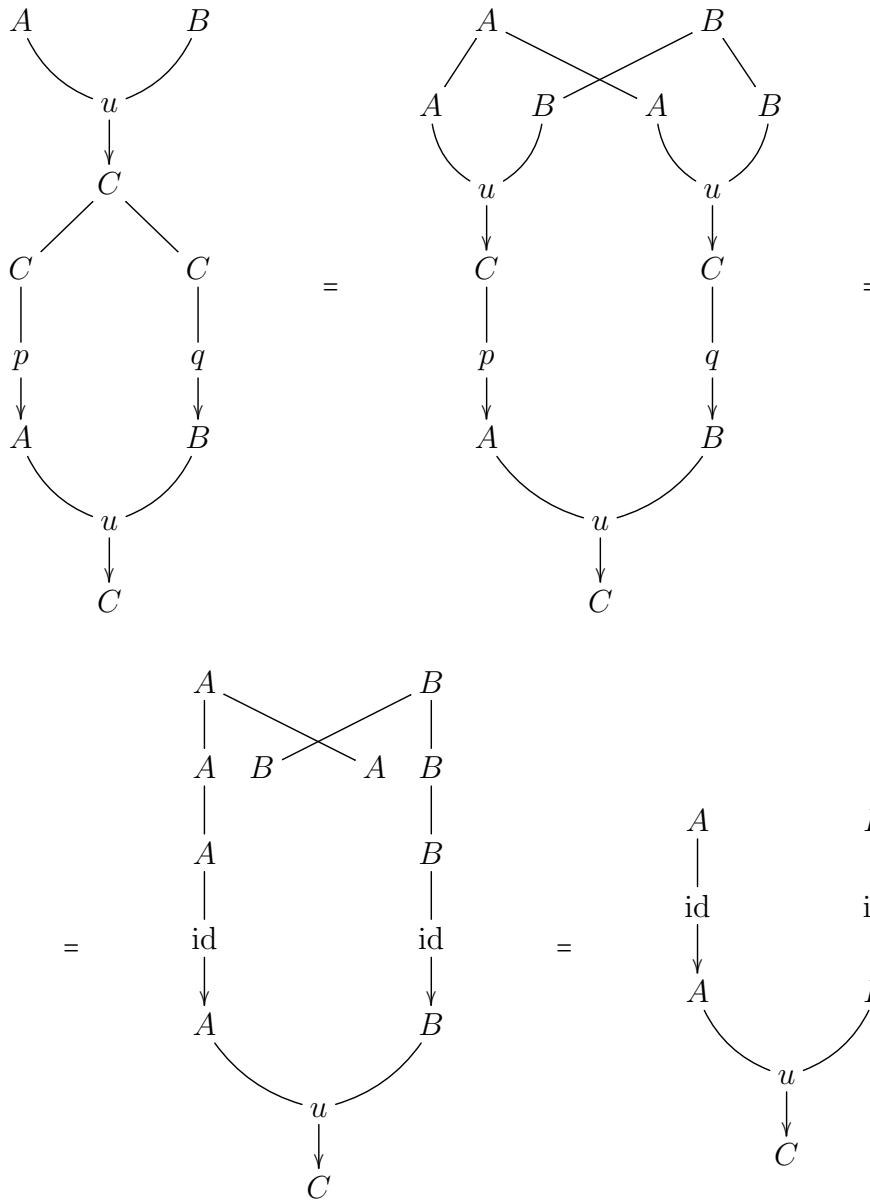

Finally, to show that (2) implies (1), assume that  $p : C \rightarrow A$  and  $q : C \rightarrow B$  are a universal product for  $A$  and  $B$  and let  $u : A, B \rightarrow C$  be the unique arrow fulfilling equations (8) in the definition of algebraic product. That we so get indeed an algebraic product follows

now from the universality of projections, since:

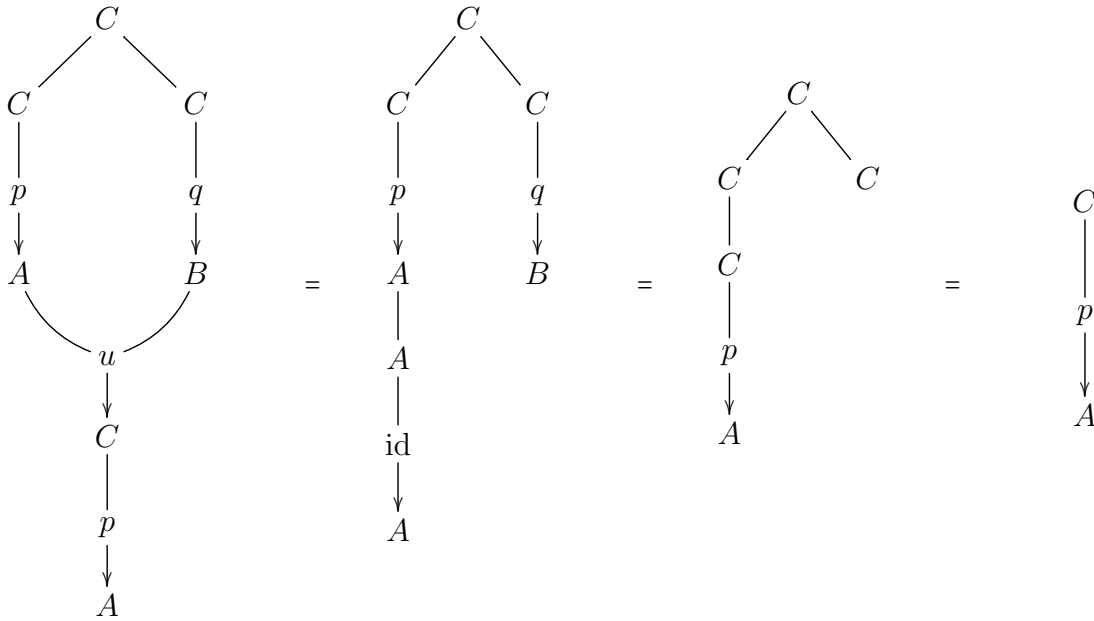

and similarly with  $q$  in place of  $p$ . ■

Suppose now that  $p : C \rightarrow A$ ,  $q : C \rightarrow B$ ,  $u : A, B \rightarrow C$  and  $l : E \rightarrow C$ ,  $r : E \rightarrow D$ ,  $v : C, D \rightarrow E$  are algebraic products in  $\mathcal{M}$ . One may wonder if their “composite”

$$pl : E \rightarrow A \quad ; \quad ql : E \rightarrow A \quad ; \quad r : E \rightarrow D \quad ; \quad v(u, D) : A, B, D \rightarrow E$$

is again an algebraic product for  $A$ ,  $B$  and  $D$ . The answer is affirmative.

**4.6. PROPOSITION.** *Algebraic products in a cartesian multicategory are closed with respect to composition.*

PROOF. We give the proof in the above case of composition of binary products.

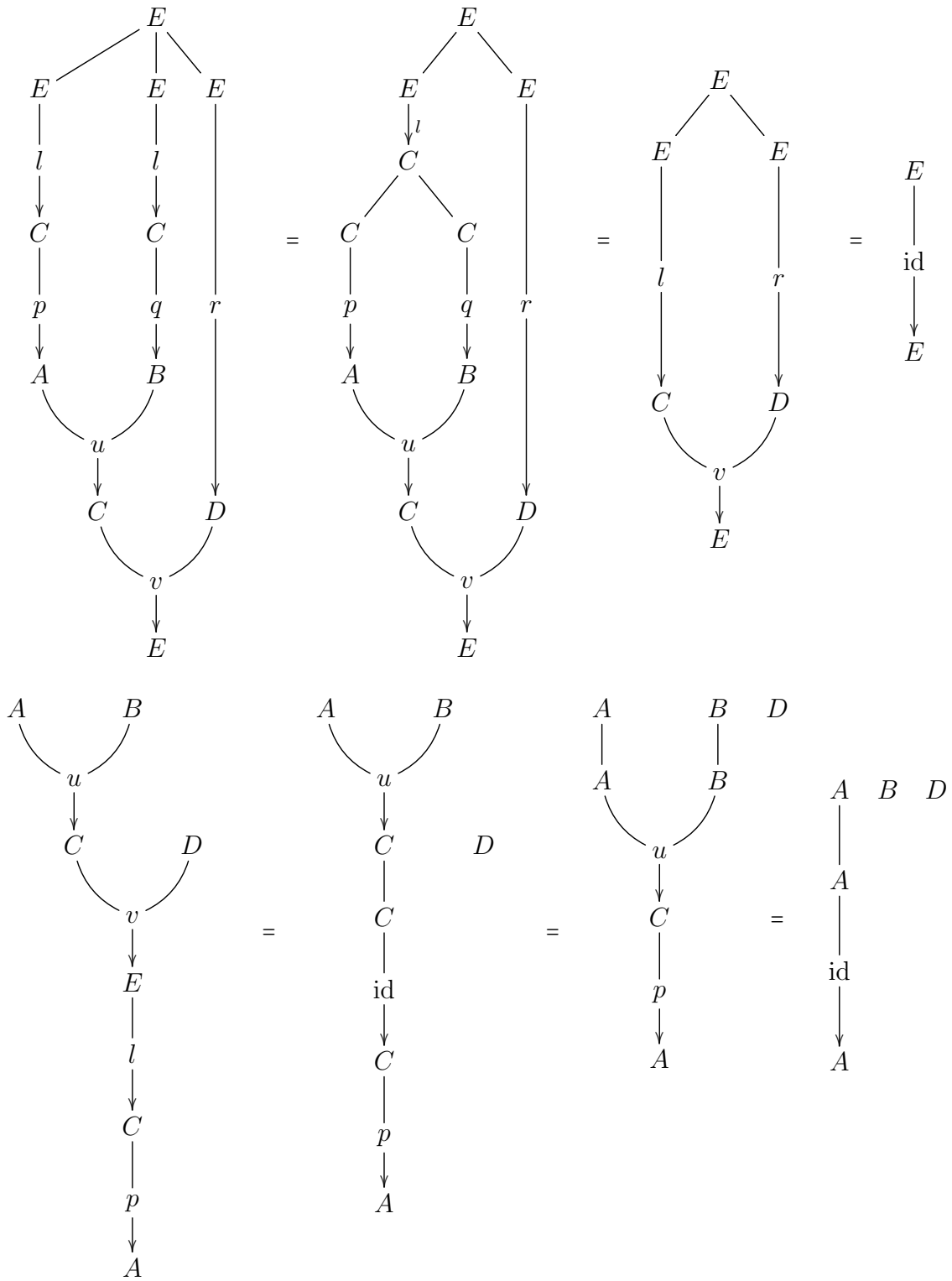

(and similarly for  $q$  in place of  $p$ ).

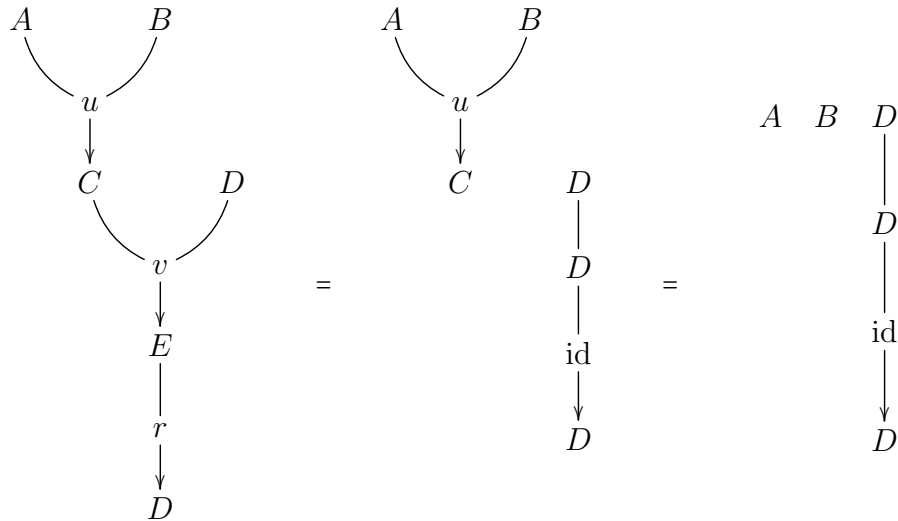

■

4.7. COROLLARY. *If a cartesian multicategory  $\mathcal{M}$  is representable then  $\mathcal{M}_-$  has finite products. If  $\mathcal{M}$  has algebraic products, then it is representable. Any functor  $F : \mathcal{M} \rightarrow \mathcal{N}$  in **fpMlt** preserves algebraic products, preuniversal arrows and universal products that exist in  $\mathcal{M}$ .*

PROOF. The first part follows directly from Proposition 4.5, since universal products in  $\mathcal{M}$  are in particular products in  $\mathcal{M}_-$ . For the second part, by Proposition 4.5 every finite family is the domain of a preuniversal arrow and by Proposition 4.6 these arrows are closed with respect to composition. Since algebraic products are clearly preserved by functors in **fpMlt**, the third part follows again from Proposition 4.5. ■

4.8. FINITE PRODUCT CATEGORIES AS CARTESIAN MULTICATEGORIES. As sketched at the beginning of this section, finite product categories give rise to cartesian multicategories. In fact, if we denote by **fpCat** the category of finite product categories and finite product preserving functors, we have:

4.9. PROPOSITION. *The category **fpRep** of representable cartesian multicategories is equivalent to **fpCat**.*

PROOF. Given a finite product category  $\mathcal{C}$ , let us fix a universal cone  $p_i : A_1 \times \dots \times A_n \rightarrow A_i$  for any finite family  $A_1, \dots, A_n$ . Then we define  $\mathcal{C}_\times \in \mathbf{fpRep}$  by

$$\mathcal{C}_\times(A_1, \dots, A_n; A) = \mathcal{C}(A_1 \times \dots \times A_n, A)$$

with the obvious composition and the following cartesian structure. If  $f : A_1, \dots, A_n \rightarrow A$ , then we define  $\sigma f = f\bar{\sigma} : B_1, \dots, B_m \rightarrow A$ , where  $\bar{\sigma} : B_1 \times \dots \times B_m \rightarrow A_1 \times \dots \times A_n$  is the map such that  $p_i\bar{\sigma} = q_{\sigma i}$ . Conversely, given a representation for  $\mathcal{M} \in \mathbf{fpRep}$  we get, as in Proposition 4.5, a universal cone in  $\mathcal{M}_-$  for any finite family  $A_1, \dots, A_n$ .

Now, it is straightforward to check that  $(\mathcal{C}_x)_- \cong \mathcal{C}$  and that, in the other direction, we have an isomorphism of multicategories  $(\mathcal{M}_-)_x \cong \mathcal{M}$  which takes an arrow  $f : A_1 \times \dots \times A_n \rightarrow A$  to  $fu : A_1, \dots, A_n \rightarrow A$  (where  $u$  is the corresponding universal arrow in the representation). To show that this isomorphism respects the cartesian structure, by Remark 4.2 we only need to check that it respects permutations and contractions, which is also straightforward.

Both the constructions  $\mathcal{C}_x$  and  $\mathcal{M}_-$  extend to functors (recall Corollary 4.7) giving the desired equivalence  $\mathbf{fpCat} \simeq \mathbf{fpRep}$ . ■

4.10. COROLLARY. *For a symmetric multicategory  $\mathcal{M}$  the following are equivalent:*

1.  $\mathcal{M}$  is cartesian and has algebraic products.
2.  $\mathcal{M}$  is cartesian and has finite universal products.
3.  $\mathcal{M}$  is cartesian and representable.
4.  $\mathcal{M}$  is cartesian monoidal, that is  $\mathcal{M} \cong \mathcal{C}_x$  for a  $\mathcal{C} \in \mathbf{fpCat}$ .

PROOF. The equivalence of the first three conditions follows from Proposition 4.5 and Corollary 4.7, while the equivalence of the last two follows from Proposition 4.9. ■

4.11. PREADDITIVE CATEGORIES AS CARTESIAN MULTICATEGORIES. We have just seen that the representable cartesian multicategories arise from finite product categories. Presently, we show that the sequential cartesian multicategories arise from preadditive categories. Note that, following other authors, we omit the prefix “semi” which is sometimes used to refer to commutative monoids (rather than abelian groups) enrichments. Thus, the category  $\mathbf{preAdd}$  of preadditive categories and additive functors is the category  $\mathbf{cMon-Cat}$  of categories enriched in commutative monoids. Similarly,  $\mathbf{Add}$  is the full subcategory of those preadditive categories with (bi)products.

4.12. PROPOSITION. *The category  $\mathbf{fpSeq}$  of sequential cartesian multicategories is equivalent to  $\mathbf{preAdd}$ .*

PROOF. Giving a preadditive structure on a category  $\mathcal{C}$  amounts to giving a cartesian structure on  $\mathcal{C}_\bullet$ . Indeed, suppose that  $\mathcal{C} \in \mathbf{preAdd}$  and let  $f = \langle f_1, \dots, f_n \rangle : A_1, \dots, A_n \rightarrow A$  be an arrow in  $\mathcal{C}_\bullet$ . We define  $\sigma f = \langle g_1, \dots, g_m \rangle : B_1, \dots, B_m \rightarrow A$  by

$$g_i = \sum_{\sigma k=i} f_k$$

and it is straightforward to check that (because of distributivity of composition) this is indeed a cartesian structure on  $\mathcal{C}_\bullet$ .

Conversely, if  $\mathcal{C}_\bullet$  has a cartesian structure the contraction mappings give a preadditive structure on  $\mathcal{C}$  and the processes are easily seen to be each other’s inverse. (Again, by Remark 4.2 it is enough to check that the cartesian structures on  $\mathcal{C}_\bullet$  coincide on contractions.) Thus, the equivalence  $(-)_- \dashv (-)_\bullet : \mathbf{Cat} \rightarrow \mathbf{Seq}$  lifts to the desired equivalence  $\mathbf{preAdd} \simeq \mathbf{fpSeq}$ . ■

4.13. **REMARK.** By propositions 3.16 and 4.9, we know that a sequential (respectively, cartesian) multicategory  $\mathcal{M}$  is representable if, and only if,  $\mathcal{M}_-$  has finite sums (respectively, products) if, and only if,  $\mathcal{M}$  is represented by sums (respectively, products). Thus, Proposition 4.12 makes precise the idea that preadditive categories are those categories in which finite sums and finite products coincide, whenever they do exist (see also Corollary 4.16).

4.14. **REMARK.** For a category  $\mathcal{C} \in \mathbf{Cat}$ , one has

$$(FC)_\blacktriangleright \cong F(\mathcal{C}_\blacktriangleright)$$

where the  $F$  on the left is the usual free preadditive category functor, while that on the right is the free cartesian multicategory functor. That is,  $F \dashv U : \mathbf{fpMlt} \rightarrow \mathbf{sMlt}$  restricts, on sequential multicategories, to the usual adjunction  $F \dashv U : \mathbf{preAdd} \rightarrow \mathbf{Cat}$ .

4.15. **COMPARISON WITH CLASSICAL ALGEBRAIC PRODUCTS.** It is well known (see for instance [MacLane, 1971]) that in a preadditive category  $\mathcal{C}$  the existence of finite products and of finite sums are equivalent (to the additivity of  $\mathcal{C}$ ), since both of them amount to the “algebraic” (rather than universal) notion of biproduct. We are now in a position to show that this is just a particular case of Corollary 4.10.

4.16. **COROLLARY.** *For a category  $\mathcal{C}$  the following are equivalent:*

1.  $\mathcal{C}$  is preadditive and has algebraic biproducts.
2.  $\mathcal{C}$  is preadditive and has finite products.
3.  $\mathcal{C}$  is preadditive and has finite sums.
4.  $\mathcal{C}$  has both finite products and finite sums and they coincide.

**PROOF.** First observe that the definition of an algebraic product of  $A, B \in \mathcal{M}$  becomes, for  $\mathcal{M} \cong \mathcal{C}_\blacktriangleright$  ( $\mathcal{C}$  preadditive), an object  $C$  along with maps  $p : C \rightarrow A$ ,  $q : C \rightarrow B$ ,  $i : A \rightarrow C$  and  $j : B \rightarrow C$  such that

$$\begin{array}{ccc}
 & C & \\
 & \swarrow \quad \searrow & \\
 C & & C \\
 \downarrow p & & \downarrow q \\
 A & & B \\
 \swarrow i & & \searrow j \\
 & C &
 \end{array}
 =
 \begin{array}{c}
 C \\
 \downarrow \text{id} \\
 C
 \end{array}$$

which, recalling that contractions in  $\mathcal{C}_\blacktriangleright$  are given by sums of arrows in  $\mathcal{C}$ , translates as

$$ip + jq = \text{id}_C$$

and such that

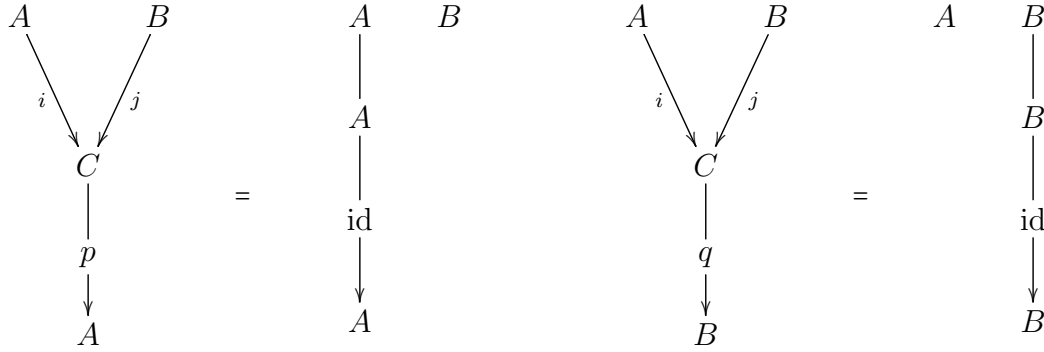

which translate as

$$pi = \text{id}_A \quad ; \quad pj = 0_{B,A} \quad ; \quad qj = \text{id}_B \quad ; \quad qi = 0_{A,B}$$

(The same argument can be of course repeated for any finite family of objects.) Thus equations (7) and (8) become, for  $\mathcal{M} \cong \mathcal{C}_\blacktriangleright$ , the classical equations giving algebraic biproducts. Therefore, when  $\mathcal{M}$  is sequential the first condition of Corollary 4.10 becomes the first condition listed above.

Now, recalling Proposition 4.12 and Remark 4.13 it is easy to see that also the other conditions of Corollary 4.10 become, when  $\mathcal{M}$  is sequential, the conditions listed above which are therefore equivalent. ■

4.17. THE ADDITIVE COREFLECTION. Our next goal is to show that the commutative monoids functor  $[1_\blacktriangleright, -] : \mathbf{sMlt} \rightarrow \mathbf{Seq}$  lifts to the cartesian level, giving a coreflection  $[1_\blacktriangleright, -] : \mathbf{fpMlt} \rightarrow \mathbf{fpSeq}$ .

4.18. PROPOSITION. *If  $\mathcal{N}$  is a cartesian multicategory then, for any  $\mathcal{M} \in \mathbf{sMlt}$ ,  $[\mathcal{M}, \mathcal{N}]$  is also cartesian in a natural way.*

PROOF. The cartesian structure on  $[\mathcal{M}, \mathcal{N}]$  is inherited pointwise from that of  $\mathcal{N}$ . For instance, the contraction  $\alpha' : F \rightarrow G$  of  $\alpha : F, F \rightarrow G$  is given by

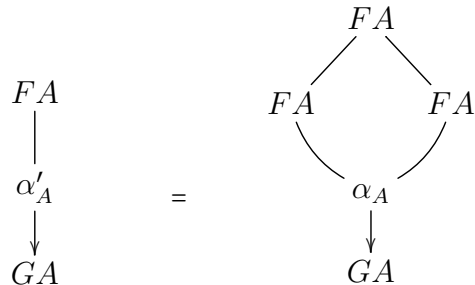



Since the conditions for a cartesian multicategory are clearly inherited pointwise from  $\mathcal{N}$ , we only have to check that  $\alpha' : F \rightarrow G$  is indeed an arrow in  $[\mathcal{M}, \mathcal{N}]$ :

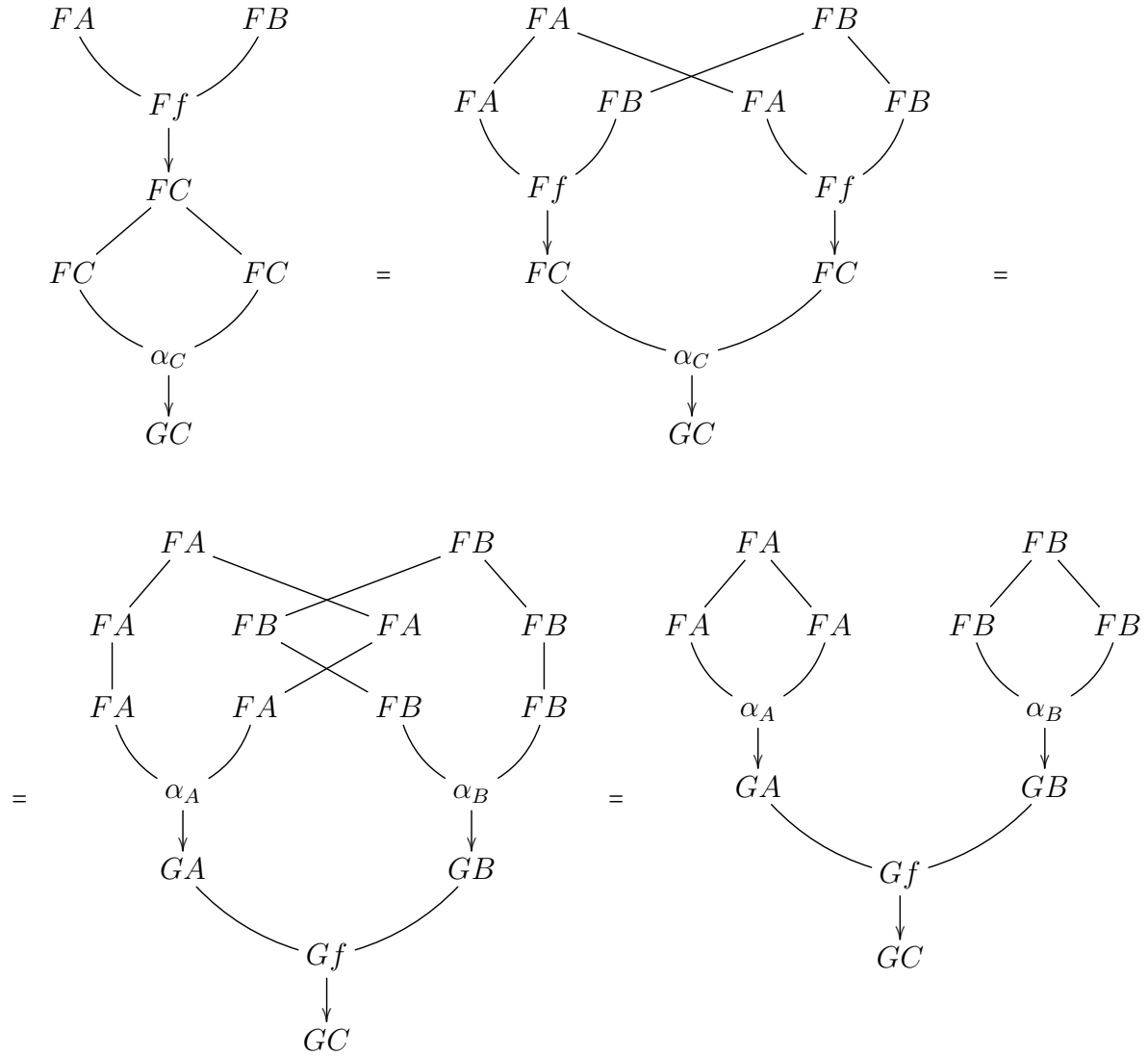

Similarly, for weakenings we have:

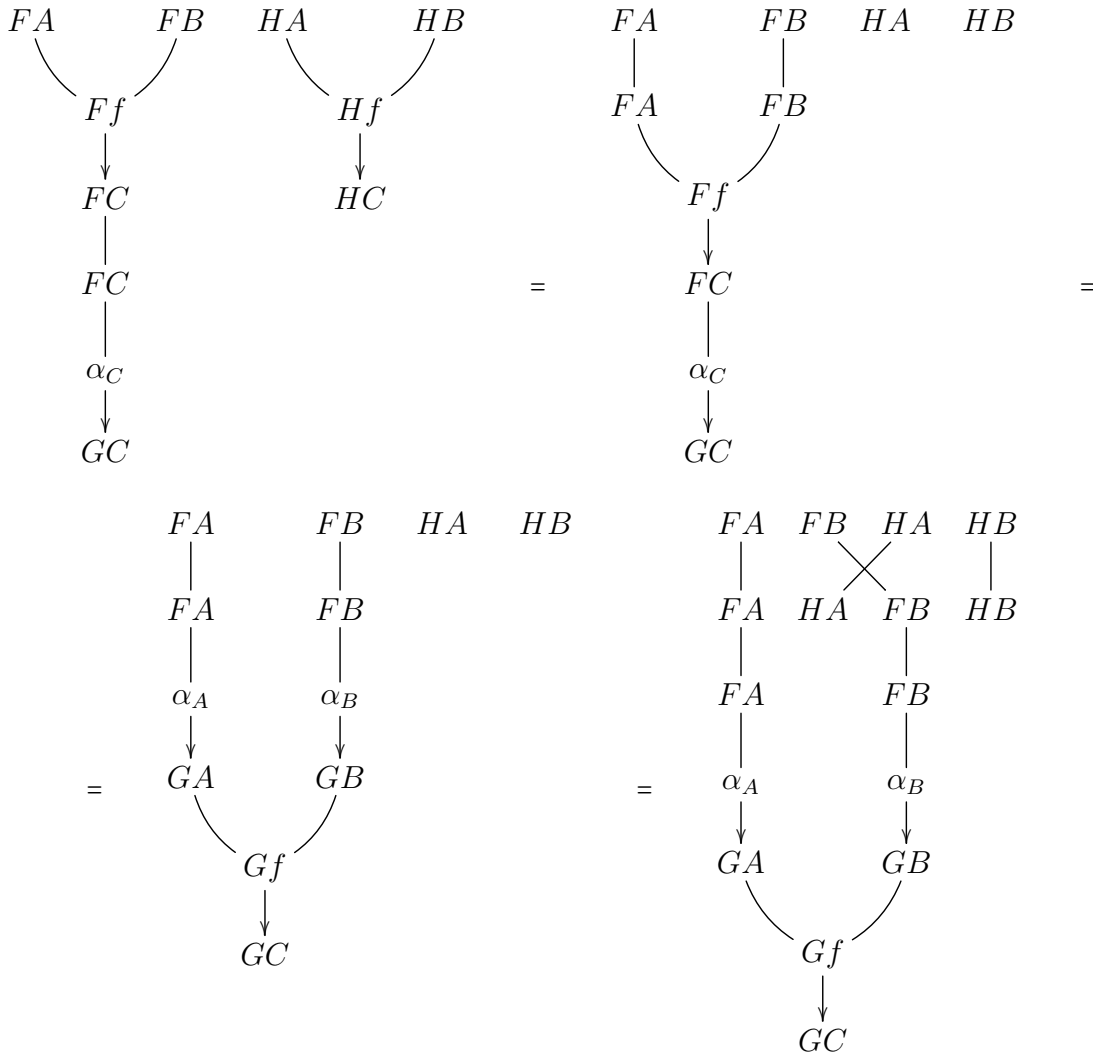

■

4.19. COROLLARY. *The functor  $[1_\blacktriangleright, -]$  gives the coreflection of  $\mathbf{fpMlt}$  in  $\mathbf{fpSeq}$ . Thus, the preadditive categories are exactly those of the form  $\mathbf{cMon}(\mathcal{M})$ , for a cartesian multicategory  $\mathcal{M}$ .*

PROOF. By Corollary 3.9,  $[1_\blacktriangleright, -]$  gives the coreflection of  $\mathbf{sMlt}$  in  $\mathbf{Seq}$  and, by Proposition 4.18, if  $\mathcal{M}$  is cartesian so it is also  $[1_\blacktriangleright, \mathcal{M}]$ . Furthermore, arrows  $\alpha : M_1, \dots, M_n \rightarrow M$  in  $[1_\blacktriangleright, \mathcal{M}]$  are arrows  $\alpha_* : A_1, \dots, A_n \rightarrow A$  in  $\mathcal{M}$  between the underlying objects (satisfying the commutativity conditions of Remark 3.2) and  $\sigma\alpha$  is computed as  $\sigma\alpha_*$ .

Thus, in the correspondence

$$\frac{\mathcal{C}_\blacktriangleright \rightarrow \mathcal{M}}{\mathcal{C}_\blacktriangleright \rightarrow [1_\blacktriangleright, \mathcal{M}]}$$

the upper functor preserves the cartesian structure if, and only if, the lower one does. ■

Since  $[1, -]$  preserves representability (by Proposition 3.17), it also gives the coreflection of  $\mathbf{fpRep} \simeq \mathbf{fpCat}$  in  $\mathbf{fpRep} \cap \mathbf{fpSeq} \simeq \mathbf{Add}$ .

4.20. COROLLARY. *The commutative monoids construction gives the coreflection of  $\mathbf{fpCat}$  in  $\mathbf{Add}$ . Thus, the additive categories are exactly those of the form  $\mathbf{cMon}(\mathcal{C})$ , for a finite product category  $\mathcal{C}$ . ■*

4.21. THE MULTICATEGORY OF CARTESIAN FUNCTORS. If  $\mathcal{M}$  and  $\mathcal{N}$  are cartesian multicategories, we denote by  $[\mathcal{M}, \mathcal{N}]_{fp}$  the full sub-multicategory of  $[\mathcal{M}, \mathcal{N}]$  whose objects are functors in  $\mathbf{fpMlt}$ . Since the cartesian structure and sequentiality are inherited by  $[\mathcal{M}, \mathcal{N}]$  from  $\mathcal{N}$ , as well as by full sub-multicategories, it follows that  $[\mathcal{M}, \mathcal{N}]_{fp}$  has a natural cartesian structure and that it is sequential whenever  $\mathcal{N}$  is so. More interestingly, also representability is inherited by  $[\mathcal{M}, \mathcal{N}]_{fp}$  from  $\mathcal{N}$ .

4.22. PROPOSITION. *If  $\mathcal{M}$  and  $\mathcal{N}$  are cartesian multicategories and  $\mathcal{N}$  is representable, then  $[\mathcal{M}, \mathcal{N}]_{fp}$  is also representable.*

PROOF. Recall from Proposition 3.17 that given functors  $F, G : \mathcal{M} \rightarrow \mathcal{N}$  and a family of universal arrows  $u_A : FA, GA \rightarrow HA$ , one gets a functor  $H : \mathcal{M} \rightarrow \mathcal{N}$  and an arrow  $u : F, G \rightarrow H$  universal in  $[\mathcal{M}, \mathcal{N}]$ . Thus we only have to check that if  $F$  and  $G$  are functors in  $\mathbf{fpMlt}$ , then so  $H$ . Let us show for instance that  $H$  preserves the contraction  $f' : A \rightarrow B$  of  $f : A, A \rightarrow B$ .

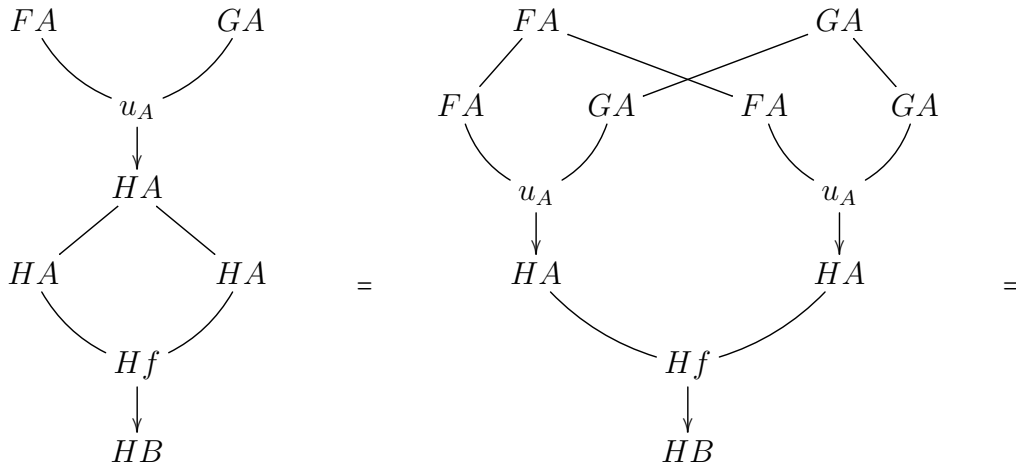

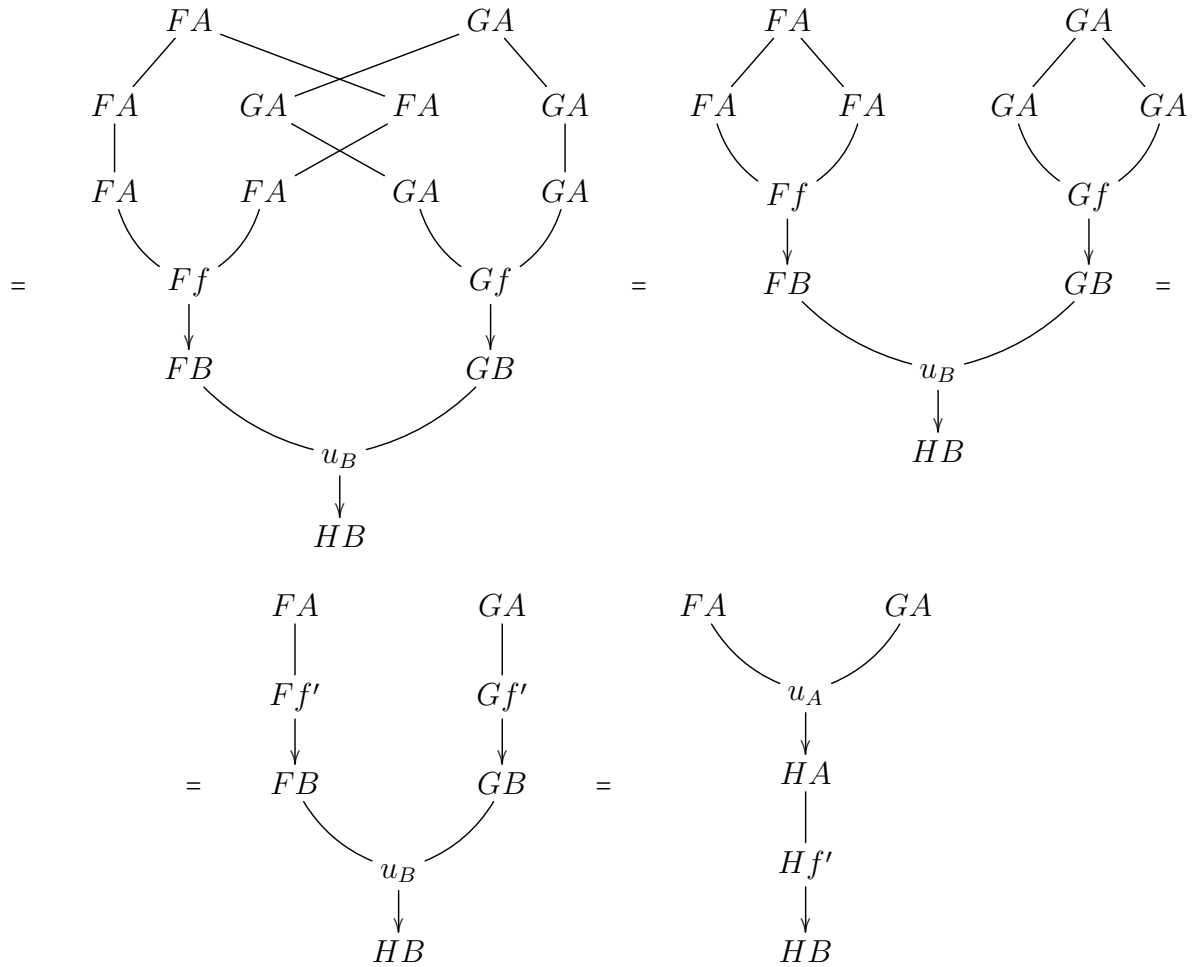

4.23. **REMARK.** The following well-known facts can be seen as particular cases of the above proposition when  $\mathcal{M}$  is also representable or when  $\mathcal{M}$  and  $\mathcal{N}$  are sequential, respectively:

- if  $\mathcal{C}$  and  $\mathcal{D}$  are finite product categories, then  $[\mathcal{C}, \mathcal{D}]_{fp}$  has (pointwise) finite products;
- if  $\mathcal{C}$  is preadditive and  $\mathcal{D}$  is additive, then  $[\mathcal{C}, \mathcal{D}]_{add}$  has a (pointwise) additive structure.

4.24. **THE MONOIDAL CLOSED STRUCTURE OF  $\mathbf{fpMlt}$ .** The cartesian multicategory  $[\mathcal{M}, \mathcal{N}]_{fp}$  is in fact the internal hom for a symmetric monoidal closed structure on  $\mathbf{fpMlt}$ . The tensor product is the free cartesian multicategory generated by the same arrows and relations defining the monoidal structure on  $\mathbf{sMlt}$ . The unit is  $F1^-$ , the free cartesian multicategory generated by  $1^-$ .

This monoidal structure restricts, on  $\mathbf{fpSeq} \simeq \mathbf{preAdd}$ , to the usual monoidal structure on  $\mathbf{cMon}$ -enriched categories. Furthermore, the role played by  $\mathbf{1}_\bullet$  in  $\mathbf{sMlt}$  is played

here by  $F1_{\blacktriangleright} \cong \mathbf{N}_{\blacktriangleright}$ , where  $\mathbf{N}$  is the rig of natural numbers (see Remark 4.14). Indeed, we have the following analog of Corollary 3.9.

4.25. PROPOSITION. *The functors  $\mathbf{N}_{\blacktriangleright} \otimes_{fp} -$  and  $[\mathbf{N}_{\blacktriangleright}, -]_{fp}$  give respectively a reflection and a coreflection of  $\mathbf{fpMlt}$  in  $\mathbf{fpSeq}$ .*

PROOF. The coreflection formula follows from Corollary 4.19, since

$$[\mathbf{N}_{\blacktriangleright}, \mathcal{M}]_{fp} \cong [F1_{\blacktriangleright}, \mathcal{M}]_{fp} \cong [1_{\blacktriangleright}, \mathcal{M}]$$

As for the reflection,  $\mathbf{N}_{\blacktriangleright} \otimes_{fp} \mathcal{M}$  is sequential (since it has a central monoid) and, for any sequential  $\mathcal{L}$ , we have natural isomorphisms

$$\frac{\mathbf{N}_{\blacktriangleright} \otimes_{fp} \mathcal{M} \rightarrow \mathcal{L}}{\mathcal{M} \rightarrow [\mathbf{N}_{\blacktriangleright}, \mathcal{L}]_{fp}} \\ \mathcal{M} \rightarrow \mathcal{L}$$

■

Similar results concerning the reflection of Lawvere theories in annular theories are stated in [Freyd, 1966], [Lawvere, 2004] and [Wraith, 1970]. Note that, on the other hand, the coreflection  $[\mathbf{N}_{\blacktriangleright}, -]_{fp}$  can not work in the single sorted context, since a single-coloured operad may of course support several commutative monoids. This gives further evidence to the fact that the categories  $\mathbf{sMlt}$  and  $\mathbf{fpMlt}$  are much more natural and effective than their single sorted counterparts, which lack natural closed structures.

## References

- J. Adamek, J. Rosicky, E.M. Vitale (2011), *Algebraic theories: a categorical introduction to general algebra*, Cambridge tracts in mathematics, **184**.
- J. M. Boardman, R. M. Vogt (1973), *Homotopy invariant algebraic structures on topological spaces*, Lecture Notes in Mathematics, **347**, Springer-Verlag.
- B. Day, E. Panchadcharam, R. Street (2005), *On centres and lax centres for promonoidal categories*, Colloque International Charles Ehresmann : 100 ans Universite de Picardie Jules Verne, Amiens.
- T. Fiore (2006), *Pseudo limits, biadjoints, and pseudo algebras : Categorical foundations of conformal field theory*, Memoirs of the American Mathematical Society, 182(860), math.CT/04028298.
- T. Fox (1976) Coalgebras and cartesian categories, *Communications in Algebra*, **4(7)**, 665-667.

- P. Freyd (1966), Algebra valued functors in general and tensor products in particular, *Colloquium mathematicum* **14**, 89-106.
- M. Gould (2008), *Coherence for categorified operadic theories*, PhD Thesis, math.CT/1002.0879.
- C. Hermida (2000), Representable multicategories, *Advances in Math.*, **151**, 164-225.
- J. Lambek (1989), *Multicategories revisited*, in: Contemporary Mathematics 92 (Amer. Math. Soc., Providence), 217-239.
- F.W. Lawvere (2004), Functorial semantics of algebraic theories and some algebraic problems in the context of functorial semantics of algebraic theories, *Reprints in Theory and Appl. of Cat.* **5**, 1-121.
- T. Leinster (2003), *Higher operads, higher categories*, Cambridge University Press, math.CT/0305049.
- S. MacLane (1971), *Categories for the working mathematician*, Springer-Verlag.
- I. Moerdijk, I. Weiss (2007), Dendroidal sets, *Algebr. Geom. Topol.* **7**, 1441-1470.
- C. Pisani (2013), *Some remarks on multicategories and additive categories*, math.CT/1304.3033.
- S.N. Tronin (2011), Natural multitransformations of multifunctors, *Russian Mathematics*, **55(11)**, 49-60.
- F. Trova (2010), *On the Geometric Realization of Dendroidal Sets*, Master Thesis, Leiden University, University of Padova.
- I. Weiss (2011), *From operads to dendroidal sets*, in: Mathematical Foundations of Quantum Field and Perturbative String Theory, Proc. of Symp. in Pure Math. AMS, **83**, 21-70.
- G. Wraith (1970), Algebraic theories, Lecture Notes Series **22**, Matematisk Institut, Aarhus Universitet.

via Saluzzo 67,  
10125 Torino, Italy.

Email: [pisclau@yahoo.it](mailto:pisclau@yahoo.it)

This article may be accessed at <http://www.tac.mta.ca/tac/>

THEORY AND APPLICATIONS OF CATEGORIES (ISSN 1201-561X) will disseminate articles that significantly advance the study of categorical algebra or methods, or that make significant new contributions to mathematical science using categorical methods. The scope of the journal includes: all areas of pure category theory, including higher dimensional categories; applications of category theory to algebra, geometry and topology and other areas of mathematics; applications of category theory to computer science, physics and other mathematical sciences; contributions to scientific knowledge that make use of categorical methods.

Articles appearing in the journal have been carefully and critically refereed under the responsibility of members of the Editorial Board. Only papers judged to be both significant and excellent are accepted for publication.

Full text of the journal is freely available in .dvi, Postscript and PDF from the journal's server at <http://www.tac.mta.ca/tac/> and by ftp. It is archived electronically and in printed paper format.

**SUBSCRIPTION INFORMATION** Individual subscribers receive abstracts of articles by e-mail as they are published. To subscribe, send e-mail to [tac@mta.ca](mailto:tac@mta.ca) including a full name and postal address. For institutional subscription, send enquiries to the Managing Editor, Robert Rosebrugh, [rrosebrugh@mta.ca](mailto:rrosebrugh@mta.ca).

**INFORMATION FOR AUTHORS** The typesetting language of the journal is  $\text{\TeX}$ , and  $\text{\LaTeX}2\epsilon$  strongly encouraged. Articles should be submitted by e-mail directly to a Transmitting Editor. Please obtain detailed information on submission format and style files at <http://www.tac.mta.ca/tac/>.

**MANAGING EDITOR.** Robert Rosebrugh, Mount Allison University: [rrosebrugh@mta.ca](mailto:rrosebrugh@mta.ca)

**$\text{\TeX}$  EDITOR.** Michael Barr, McGill University: [barr@math.mcgill.ca](mailto:barr@math.mcgill.ca)

**ASSISTANT  $\text{\TeX}$  EDITOR.** Gavin Seal, Ecole Polytechnique Fédérale de Lausanne: [gavin\\_seal@fastmail.fm](mailto:gavin_seal@fastmail.fm)

**TRANSMITTING EDITORS.**

Clemens Berger, Université de Nice-Sophia Antipolis: [cberger@math.unice.fr](mailto:cberger@math.unice.fr)

Richard Blute, Université d' Ottawa: [rblute@uottawa.ca](mailto:rblute@uottawa.ca)

Lawrence Breen, Université de Paris 13: [breen@math.univ-paris13.fr](mailto:breen@math.univ-paris13.fr)

Ronald Brown, University of North Wales: [ronnie.profbrown\(at\)btinternet.com](mailto:ronnie.profbrown(at)btinternet.com)

Valeria de Paiva: [valeria.depaiva@gmail.com](mailto:valeria.depaiva@gmail.com)

Ezra Getzler, Northwestern University: [getzler\(at\)northwestern\(dot\)edu](mailto:getzler(at)northwestern(dot)edu)

Kathryn Hess, Ecole Polytechnique Fédérale de Lausanne: [kathryn.hess@epfl.ch](mailto:kathryn.hess@epfl.ch)

Martin Hyland, University of Cambridge: [M.Hyland@dpmms.cam.ac.uk](mailto:M.Hyland@dpmms.cam.ac.uk)

Anders Kock, University of Aarhus: [kock@imf.au.dk](mailto:kock@imf.au.dk)

Stephen Lack, Macquarie University: [steve.lack@mq.edu.au](mailto:steve.lack@mq.edu.au)

F. William Lawvere, State University of New York at Buffalo: [wlawvere@buffalo.edu](mailto:wlawvere@buffalo.edu)

Tom Leinster, University of Edinburgh: [Tom.Leinster@ed.ac.uk](mailto:Tom.Leinster@ed.ac.uk)

Ieke Moerdijk, Radboud University Nijmegen: [i.moerdijk@math.ru.nl](mailto:i.moerdijk@math.ru.nl)

Susan Niefield, Union College: [niefiels@union.edu](mailto:niefiels@union.edu)

Robert Paré, Dalhousie University: [pare@mathstat.dal.ca](mailto:pare@mathstat.dal.ca)

Jiri Rosicky, Masaryk University: [rosicky@math.muni.cz](mailto:rosicky@math.muni.cz)

Giuseppe Rosolini, Università di Genova: [rosolini@disi.unige.it](mailto:rosolini@disi.unige.it)

Alex Simpson, University of Edinburgh: [Alex.Simpson@ed.ac.uk](mailto:Alex.Simpson@ed.ac.uk)

James Stasheff, University of North Carolina: [jds@math.upenn.edu](mailto:jds@math.upenn.edu)

Ross Street, Macquarie University: [street@math.mq.edu.au](mailto:street@math.mq.edu.au)

Walter Tholen, York University: [tholen@mathstat.yorku.ca](mailto:tholen@mathstat.yorku.ca)

Myles Tierney, Rutgers University: [tierney@math.rutgers.edu](mailto:tierney@math.rutgers.edu)

Robert F. C. Walters, University of Insubria: [rfcwalters@gmail.com](mailto:rfcwalters@gmail.com)

R. J. Wood, Dalhousie University: [rjwood@mathstat.dal.ca](mailto:rjwood@mathstat.dal.ca)